

MASTER CATALOG 2019

Interior

Door Feeder

Jamb Routers

Exterior

Architectural

Patio Door Line

Entry Door Line

Automatic Saws

Pre-Fit Jamb

Bi-fold





Making Quality Door and Jamb Machinery Since 1947

INNOVATION | QUALITY | HONESTY

Order Today!
Call 1.800.553.5825

About KVAL Machinery

KVAL was started in the mid 1940's by AA Kvalheim. A Norwegian trained furniture maker, who turned to cabinetmaking and carpentry, and eventually machinery manufacturing after immigrating to the United States. One product produced in the mid 40's was a panel saw which helped expand the fledgling flush door industry that was developing around the Walled Lake, Michigan area. Early door sizing systems were supplied to companies like Young Door, Walled Lake, Arrow Door, and out on the west coast to Cal Wood Door.

In the mid 1950's, sons Andy and Irv Kvalheim joined in the business. As the company grew, so did the line of products. Door pre-hanging equipment was designed for distributors and high production equipment was designed for manufacturers producing pre-fit units. During the growth years of the 60's, the company continued as an innovator in the industry with automatic machines for jamb processing, casing trimmers and updated door sizers. As the 70's began, customers began demanding even more automation to cut labor costs and improve product quality. Kval responded with bi-fold door assembly and pre-hanging machines featuring fully automatic screw driving systems.

In the 1980's Jerry, David, and Mark Kvalheim...the three grandsons of AA Kvalheim have joined the firm. The company family has also grown to include George Kameoka as head engineer, and Mark Smith as one of the managing partners.

Today the fourth generation Kelly, Zack and Nate Kvalheim, sons of David and daughter of Jerry have joined firm and are managing the company. The equipment continues to move forward in automation, speed and efficiency. Recent models like the 994-X are servo controlled and can process up to 500 doors in an 8 hour shift with one door taking just one minute to process.

KVAL products have continued to evolve and are now faster than ever, but are easier to set up, and produce higher quality doors than ever before. Recent technical innovations include CNC controls and the complete replacement of air logic control systems with solid state programmable controllers. Fully automatic positioning and sequencing for door and jamb equipment. Digital readouts with touchscreen controls to guarantee accurate setup and operation. When looking for quality door, jamb, casing, and related machines, look to the leader in the industry for over seven decades!

Look to KVAL!!!



This document may not be copied, photocopied, reproduced, transmitted, or translated in any form or for any purpose without the express written consent of KVAL Inc.
KVAL Inc. reserved the rights, without notice, to change design and construction of any products.

Price are subject to change without notice.
Errors in description, photography, or typographical errors are subject to correction.

Printed in the United States of America
Published on 11/15/2019



AIR	6 - 48 ▶
ELECTRICAL	49 - 82 ▶
PAINT & ADHESIVE	83 - 84 ▶
HARDWARE	85 - 111 ▶
FASTENERS	112 - 119 ▶
POWER TRANSMISSION	120 - 145 ▶
SAFETY SUPPLIES	146 - 155 ▶
TOOLING	156 - 195 ▶
TOOLS & EQUIPMENT	196 - 200 ▶



KVALINC.COM
Open 24 hours a day, seven days a week.

CATALOG
Call 1-800-553-5825 to order.

FAX
Fax your order at 1-707-762-0485

E-Mail
Send to Parts@kvalinc.com

4 WAYS TO SHOP 





Making Quality Door and Jamb Machinery Since 1947

INNOVATION | QUALITY | HONESTY

Order Today!
Call 1.800.553.5825



Service Department



Why Go Anywhere Else?

We Feature

- Certified, Factory trained Service technicians
- Factory-authorized warranty & parts
- All Work guaranteed
- Friendly service advisors
- Up-front competitive pricing
- State-of-the-art equipment

Multi-Point Inspection



- | | | | |
|----------------|-----------------|-------------------------|--------------------------|
| Inspect FRL | Clamp Alignment | Inspect Sensors & Cords | Flow Control Adjustments |
| Clamp Pressure | Check Feed Rate | Tooling | Inspect/Align 6 Shooter |
| Chain Wear | Check Bearing | | |

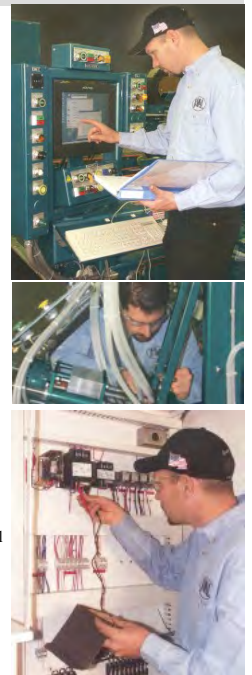

Parts Department Hours



Monday thru Thursday
6:00 a.m. to 4:00 p.m. Pacific Time

Friday
6:00 a.m. to 1:00 p.m.

Email: orders@kvalinc.com

Fax: 1-707-762-0485

We ship it your way! Around the block ... around the world!



Packages can be up to 150 lbs (70 kg).
Packages can be up to 165 inches (419 cm) in length and girth combined.
Packages can be up to 108 inches (270 cm) in length.
Packages with a large size-to-weight ratio require special pricing and dimensional weight calculations.

Up to 150 lbs. each; up to 119" in length, 165" in length plus girth (L+2W+2H).





Making Quality Door and Jamb Machinery Since 1947

INNOVATION | QUALITY | HONESTY

Order Today!
Call 1.800.553.5825

All KVAL Catalogs & Manuals are Available at www.kvalinc.com

1.) Hover above Support tab, then click Machine Support.

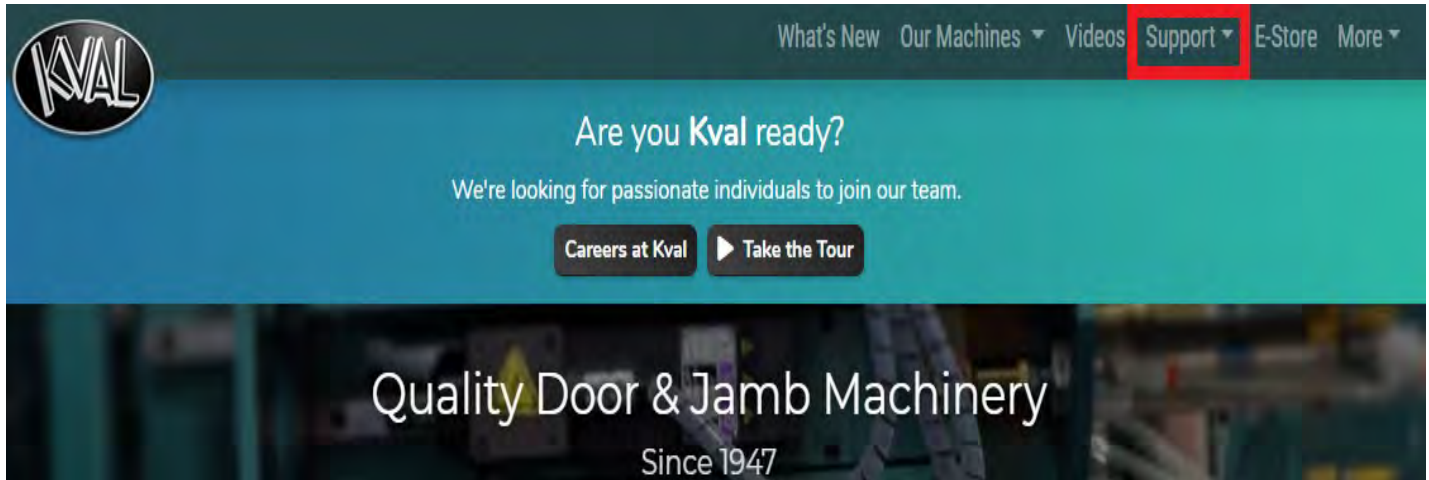

2.) Click drop down arrow on the right and select the machine model you wish to view.

Machine Support MAINTENANCE & TRAINING RESOURCES

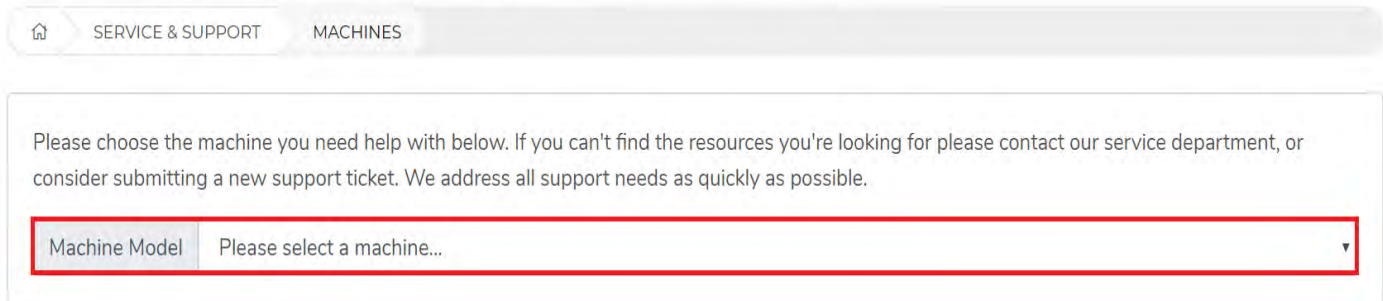

3.) All available catalogs & videos will populate. Click the blue Download box to view

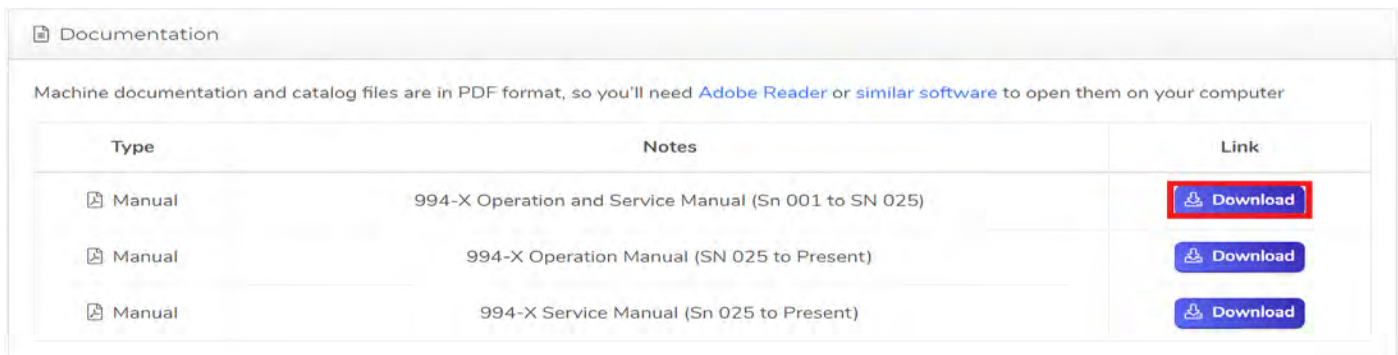



Brass Hex Nipples



216P02	Hex Nipple 1/8 Male Pipe Thread .97 Long
216P04	Hex Nipple 1/4 Male Pipe Thread 1.38 Long
216P06	Hex Nipple 3/8 Male Pipe Thread 1.41 Long
216P08	Hex Nipple 1/2 Male Pipe Thread 1.81 Long

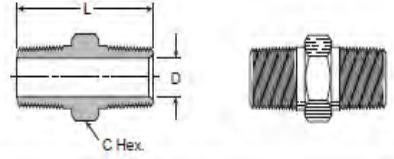

Pipe Thread	C Hex.	L	Flow Dia. D
1/8	7/16	0.97	0.220
1/4	9/16	1.38	0.314
3/8	11/16	1.41	0.440
1/2	7/8	1.81	0.564
3/4	1-1/16	1.81	0.752

Brass Nipples



215PN02	Brass Close Nipple 3/4" Long 1/8" Male Pipe Thread
215PN04	Brass Close Nipple 7/8" Long 1/4" Male Pipe Thread
215PN06	Brass Close Nipple 1" Long 3/8" Male Pipe Thread
215PN08	Brass Close Nipple 1-1/8" Long 1/2" Male Pipe Thread

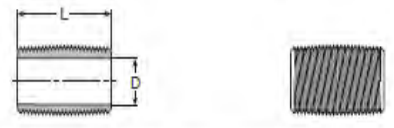

Pipe Thread	L	Flow Dia. D
1/8	0.75	0.281
1/4	0.88	0.375
3/8	1.00	0.500
1/2	1.13	0.625
3/4	1.31	0.750



215PNL215	Brass Long Nipple 1-1/2 Long 1/8 Male Pipe Thread
215PNL220	Brass Long Nipple 2 Long 1/8 Male Pipe Thread
215PNL225	Brass Long Nipple 2-1/2 Long 1/8 Male Pipe Thread
215PNL415	Brass Long Nipple 1-1/2 Long 1/4 Male Pipe Thread
215PNL420	Brass Long Nipple 2 Long 1/4 Male Pipe Thread
215PNL425	Brass Long Nipple 2-1/2 Long 1/4 Male Pipe Thread
215PNL620	Brass Long Nipple 2 Long 3/8 Male Pipe Thread
215PNL625	Brass Long Nipple 2-1/2 Long 3/8 Male Pipe Thread
215PNL820	Brass Long Nipple 2 Long 1/2 Male Pipe Thread
215PNL825	Brass Long Nipple 2-1/2 Long 1/2 Male Pipe Thread

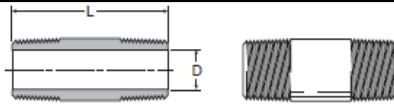

Pipe Thread	L	Flow Dia. D
1/8	1-1/2	0.250
1/4	1-1/2	0.375
3/8	1-1/2	0.500
1/2	1-1/2	0.625
1/8	2	0.250
1/4	2	0.375
3/8	2	0.500
1/2	2	0.625
1/8	2-1/2	0.250
1/4	2-1/2	0.375
3/8	2-1/2	0.500
1/2	2-1/2	0.625
1/8	3	0.250
1/4	3	0.375
3/8	3	0.500
1/2	3	0.625
1/8	3-1/2	0.250
1/4	3-1/2	0.375
3/8	3-1/2	0.500
1/2	3-1/2	0.625

Brass Plugs



218P02	Brass Plug 1/8 Male Pipe Thread Hex Head
218P04	Brass Plug 1/4 Male Pipe Thread Hex Head
218P06	Brass Plug 3/8 Male Pipe Thread Hex Head
218P08	Brass Plug 1/2 Male Pipe Thread Hex Head

Pipe Thread	C Hex.	L
1/8	7/16	0.560
1/4	9/16	0.747
3/8	11/16	0.780
1/2	7/8	0.970
3/4	1-1/16	1.054

Cross



2205P02	Brass Cross 1/8 Female Pipe Thread
2205P04	Brass Cross 1/4 Female Pipe Thread
2205P06	Brass Cross 3/8 Female Pipe Thread
2205P08	Brass Cross 1/2 Female Pipe Thread

Pipe Thread	M	Flow Dia. D
1/8	0.53	0.339
1/4	0.75	0.441
3/8	0.81	0.571
1/2	1.07	0.703
3/4	1.14	0.906

Exhaust Ball Valves



Air Safety Valve, 1/4 NPT, Preset Pressure Setting 125 PSI, Rated Flow @ Set Pressure 115 CFM
KVAL P/N: 5A708



Brass Elbow 90-Degree Union 1/4 Female Pipe Thread
KVAL P/N: BBVALVE04



Brass Elbow 90-Degree Union 1/2 Female Pipe Thread
KVAL P/N: BBVALVE08



Safety Exhaust Ball Valves, 1"
KVAL P/N: BBVALVE16

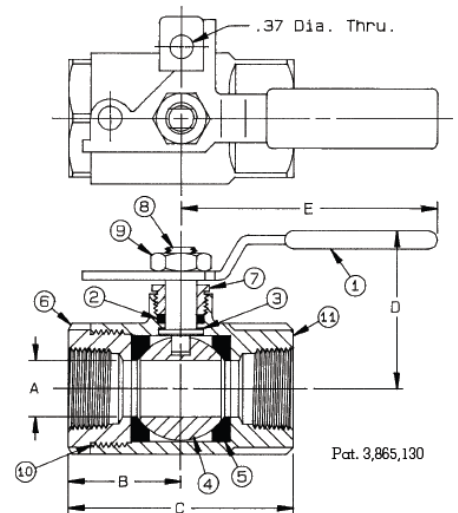

BRONZE PAD LOCKING BALL VALVE

NUMBER	SIZE	A	B	C	D	E	Wt.
75-101-01	1/4"	.43	1.10	2.22	1.74	2.87	.80
75-102-01	3/8"	.50	1.10	2.22	1.74	2.87	.77
75-103-01	1/2"	.50	1.10	2.22	1.74	2.87	.70
75-104-01	3/4"	.87	1.68	3.35	2.20	3.81	2.03
75-105-01	1"	.87	1.68	3.35	2.20	3.81	1.83
75-106-01	1-1/4"	1.00	1.98	3.97	2.56	5.50	3.48
75-107-01	1-1/2"	1.25	2.14	4.31	2.74	5.50	4.23
75-108-01	2"	1.50	2.35	4.67	2.93	5.50	5.69



Branch Tee



2224P02	Brass Branch Tee 1/8 Female to Female to Male Pipe Thread
2224P04	Brass Branch Tee 1/4 Female to Female to Male Pipe Thread
2224P06	Brass Branch Tee 3/8 Female to Female to Male Pipe Thread

Part No.	Pipe Thread	L	M	N	Flow Dia. D
2224P-2	1/8	1.06	.53	.66	.220
2224P-4	1/4	1.52	.76	.91	.314
2224P-6	3/8	1.68	.84	.97	.440
2224P-8	1/2	2.18	1.09	1.25	.564
2224P-12	3/4	2.32	1.16	1.38	.752

Street Elbow - 45 Deg



2214P22	Brass Elbow 45-Degree Street 1/8 Female to 1/8 Male Thread
2214P44	Brass Elbow 45-Degree Street 1/4 Female to 1/4 Male Pipe Thread
2214P66	Brass Elbow 45-Degree Street 3/8 Female to 3/8 Male Pipe Thread
2214P88	Brass Elbow, 45 Degree, Street Elbow, 1/2" Female to 1/2" Male Pipe Thread

Pipe Thread	M	N	Flow Dia. D
1/8	.38	.50	.220
1/4	.54	.70	.314
3/8	.54	.78	.440
1/2	.73	1.00	.564

Street Elbow - 90 Deg



2202P22	Brass Elbow 90-Degree Street 1/8 Female to 1/8 Male Pipe Thread
2202P42	Brass Elbow 90-Degree Street 1/4 Female to 1/8 Male Pipe Thread
2202P44	Brass Elbow 90-Degree Street 1/4 Female to 1/4 Male Pipe Thread
2202P66	Brass Elbow 90-Degree Street 3/8 Female to 3/8 Male Pipe
2202P88	Brass Elbow 90-Degree Street 1/2 Female to 1/2 Male Pipe Thread

1 Pipe Thread	2 Pipe Thread	M	N	Flow Dia. D
1/8	1/8	0.81	0.56	0.22
1/8	1/8	0.62	0.48	0.22
1/8	1/8	0.66	0.48	0.22
1/4	1/8	0.72	0.45	0.23
1/4	1/4	1.08	0.69	0.31
1/4	1/4	0.91	0.45	0.34
1/4	1/4	0.91	0.72	0.31
1/4	3/8	0.97	0.78	0.43
3/8	1/4	1.25	0.78	0.31
3/8	3/8	1.25	0.78	0.42
3/8	3/8	0.98	0.54	0.41
3/8	3/8	0.97	0.78	0.43
3/8	1/2	1.53	1.01	0.56
1/2	3/8	1.25	0.97	0.42
1/2	1/2	1.25	1.03	0.56
3/4	1/2	1.39	1.10	0.56
3/4	3/4	1.39	1.10	0.75

Street Tee



2225P02	Brass Street Tee 1/8 Female to Female to Male Pipe Thread
2225P04	Brass Street Tee 1/4 Female to Female to Male Pipe Thread
2225P06	Brass Street Tee 3/8 Female to Female to Male Pipe Thread
2225P08	Brass Street Tee 1/2 Female to Female to Male Pipe Thread

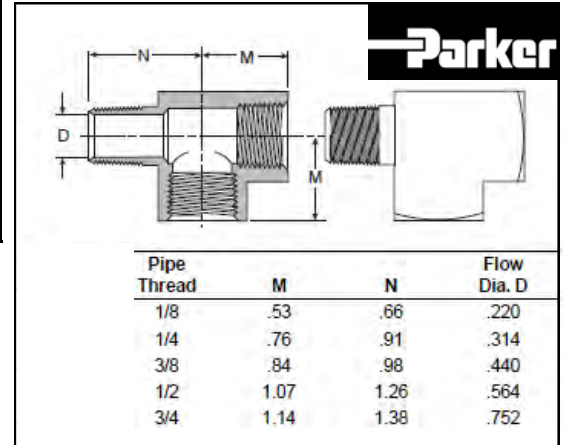

Tee



2203P02	Brass Tee 1/8 Female Pipe Thread
2203P04	Brass Tee 1/4 Female Pipe Thread
2203P06	Brass Tee 3/8 Female Pipe Thread
2203P08	Brass Tee 1/2 Female Pipe Thread

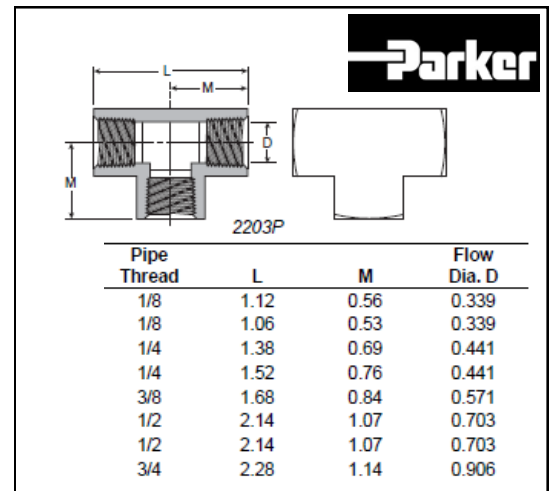

Union Elbow



2200P22	Brass Elbow 90-Degree Union 1/8 Female Pipe Thread
2200P44	Brass Elbow 90-Degree Union 1/4 Female Pipe Thread
2200P66	Brass Elbow 90-Degree Union 3/8 Female Pipe Thread
2200P88	Brass Elbow 90-Degree Union 1/2 Female Pipe Thread

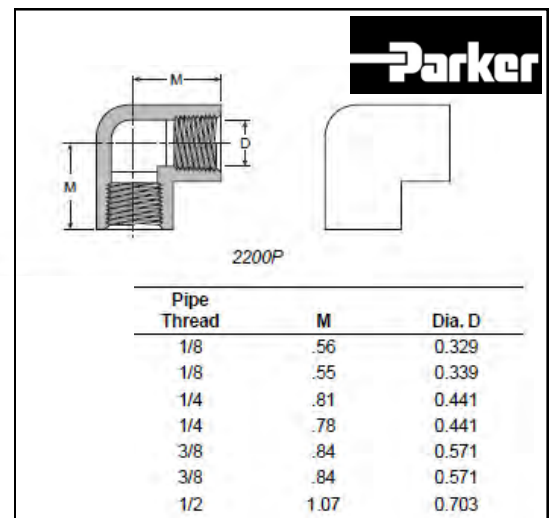

Parker Push-lok Hose Union



3018224B	Fittings, Parker Push Lok 1/8 MP - 1/4 Barb
3018244B	Fittings, Parker Push Lok 1/4 MP - 1/4 Barb
3018246B	Fittings, Parker Push Lok 1/4 MP - 3/8 Barb
3018266B	Fittings, Parker Push Lok 3/8 MP - 3/8 Barb
3018268B	Fittings, Parker Push Lok 3/8 MP - 1/2 Barb
3018286B	Fittings, Parker Push Lok 1/2 MP - 3/8 Barb
3018288B	Fittings, Parker Push Lok 1/2 MP - 1/2 Barb

Parker Push-lok Hose Union



3828244B	Fittings, Parker Hose Union, 1/4" Barb, 38282-4-4B
3828266B	Fittings, Parker Hose Union, 3/8" Barb, 38282-6-6B
3828288	Fittings, Parker Hose Union, 1/2" Barb, 38282-8-8B

Couplings



207P02	Brass Coupling 1/8" Female Pipe Thread
207P04	Brass Coupling 1/4" Female Pipe Thread
207P06	Brass Coupling 3/8" Female Pipe Thread
207P08	Brass Coupling 1/2" Female Pipe Thread



Reducer Bushings



209P42	Brass Bushing 1/4" Male to 1/8" Female Pipe Thread
209P62	Brass Bushing 3/8" Male to 1/8" Female Pipe Thread
209P64	Brass Bushing 3/8" Male to 1/4" Female Pipe Thread
209P82	Brass Bushing 1/2" Male to 1/8" Female Pipe Thread
209P84	Brass Bushing 1/2" Male to 1/4" Female Pipe Thread
209P86	Brass Bushing 1/2" Male to 3/8" Female Pipe Thread

Reducer Couplings



208P42	Brass Reducer Coupling 1/4 Female to 1/8 Female Pipe Thread
208P64	Brass Reducer Coupling 3/8 Female to 1/4 Female Pipe Thread
208P86	Brass Reducer Coupling 1/2 Female to 3/8 Female Pipe Thread



216P42	Brass Reducer 1/4 Male to 1/8 Male Pipe Thread
216P62	Brass Reducer 3/8 Male to 1/8 Male Pipe Thread
216P64	Brass Reducer 3/8 Male to 1/4 Male Pipe Thread
216P86	Brass Reducer 1/2 Male to 3/8 Male Pipe Thread

Quick Disconnect



B13 Female Couple 1/4 Air Quick Disconnect

KVAL P/N: 000B13



B2C Male Nipple 1/4 Air Quick Disconnect Brass or Steel

KVAL P/N: 000B2C

To see our full line of products,

go to kvalinc.com and type in

fittings

Find

SMC Air Fittings



Fittings, Male Swivel Elbow KQ2L Series, 5/32 Tube OD X 1/8" NPT

KVAL P/N: SMCKQ2L03-34AS



Fittings, Male Swivel Elbow KQ2L Series, 1/4 Tube OD X 1/8" NPT

KVAL P/N: SMCKQ2L07-34AS



Fittings, Male Swivel Elbow KQ2L Series, 1/4 Tube OD X 1/4" NPT

KVAL P/N: SMCKQ2L07-35AS



Fittings, Male Swivel Elbow KQ2L Series, 5/16 Tube OD X 1/4" NPT

KVAL P/N: SMCKQ2L09-35S



Fittings, Male Swivel Elbow KQ2L Series, 3/8 Tube OD X 1/4" NPT

KVAL P/N: SMCKQ2L11-35AS



Fittings, Male Swivel Elbow KQ2L Series, 3/8 Tube OD X 3/8" NPT

KVAL P/N: SMCKQ2L11-36AS



Fittings, Male Swivel Elbow KQ2L Series, 3/8 Tube OD X 1/2" NPT

KVAL P/N: SMCKQ2L11-37AS



Fittings, SMC, Double Universal Male Elbow KQ2VD, 1/4 Tube OD X 1/8 NPT

KVAL P/N: SMCKQ2VD07-34S



Fittings, SMC, Double Universal Male Elbow KQ2VD, 1/4 Tube OD X 1/4 NPT

KVAL P/N: SMCKQ2VD07-35S



Fittings, SMC, Male Branch "Y" KQ2U Series, 1/4 Tube OD X 1/8 NPT

KVAL P/N: SMCKQ2U07-34AS



Fittings, SMC, Male Branch Tee KQ2T Series, 1/4 Tube OD X 1/8 NPT

KVAL P/N: SMCKQ2T07-34S



Fittings, SMC, Male Branch Tee KQ2T Series, 1/4 Tube OD X 1/4 NPT

KVAL P/N: SMCKQ2T07-35S



SMCKQ2H07-34AS	Fittings, SMC, Male Connector KQ2H Series , 1/4 Tube OD X 1/8 NPT
SMCKQ2H07-35AS	Fittings, SMC, Male Connector KQ2H Series , 1/4 Tube OD X 1/4 NPT
SMCKQ2H07-36AS	Fittings, SMC, Male Connector KQ2H Series , 1/4 Tube OD X 3/8 NPT
SMCKQ2H09-35S	Fittings, SMC, Male Connector KQ2H Series , 5/16 Tube OD X 1/4 NPT
SMCKQ2H11-35AS	Fittings, SMC, Male Connector KQ2H Series , 3/8 Tube OD X 1/4 NPT
SMCKQ2H11-36AS	Fittings, SMC, Male Connector KQ2H Series , 3/8 Tube OD X 3/8 NPT



Fittings, SMC, Male Run Tee KQ2Y Series, 1/4 Tube OD X 1/8 NPT

KVAL P/N: SMCKQ2Y07-34AS



Fittings, SMC, Male Run Tee KQ2Y Series, 1/4 Tube OD X 1/4 NPT

KVAL P/N: SMCKQ2Y07-35S



Fittings, SMC, Plug In Elbow KQ2L Series, 1/4 Tube

KVAL P/N: SMCKQ2L07-99A



Fittings, SMC, Plug In Elbow KQ2L Series, 3/8 Tube

KVAL P/N: SMCKQ2L11-99





Fittings, SMC, Plug KQ2P Series, 1/4"

KVAL P/N: SMCKQ2P-07



Fittings, SMC, Plug KQ2P Series, 3/8"

KVAL P/N: SMCKQ2P-11



Fittings, SMC, Plug-In "Y" KQ2U Series, 1/4 Tube OD X 1/4"

KVAL P/N: SMCKQ2U07-99A



Fittings, SMC, Plug-In Reducer KQ2R Series, 5/32 Tube OD X 1/4"

KVAL P/N: SMCKQ2R03-07



Fittings, SMC, Straight Union KQ2H Series, 1/4"

KVAL P/N: SMCKQ2H07-00A



Fittings, SMC, Triple Universal Elbow KQ2VT Series, 1/4 Tube OD X 1/4 NPT

KVAL P/N: SMCKQ2VT07-35AS



Fittings, SMC, Union "Y" KQ2U Series, 1/4"

KVAL P/N: SMCKQ2U07-00A



Fittings, SMC, Union "Y" KQ2U Series, 3/8"

KVAL P/N: SMCKQ2U11-00A



Fittings, SMC, Union Elbow KQ2L, 1/4 Tube OD

KVAL P/N: SMCKQ2L07-00A



Fittings, SMC, Union Tee KQ2T Series, 1/4" Tube OD

KVAL P/N: SMCKQ2T07-00A



Fittings, SMC, Union Tee KQ2T Series, 3/8" Tube OD

KVAL P/N: SMCKQ2T11-00A

Flow Controls



Speed Controller, In-line, 1/8"

KVAL P/N: SMCAS2001



Speed Controller, Standard, 1/8" Right Angle, 1/8 NPT, Metal Body Elbow Style

KVAL P/N: SMCAS2101



Speed Controller, Standard, 1/4" Right Angle, 1/4 NPT, Metal Body Elbow Style

KVAL P/N: SMCAS2102



Speed Controller, One-touch Fitting, 1/8 NPT - 1/4" OD, Elbow & Universal Types

KVAL P/N: SMCAS2201F1



Flow Controls



Speed Controller, One-touch Fitting, 1/4 NPT - 1/4" OD, Elbow & Universal Types

KVAL P/N: SMCAS2201F2



Speed Controller, One-touch Fitting, 1/4 NPT - 3/8" OD, Elbow & Universal Types

KVAL P/N: SMCAS2201F4



Speed Controller, One-touch Fitting, 1/8 NPT - 1/4" OD, Universal Types

KVAL P/N: SMCAS2301F



Speed Controller, 1/4 NPT - 1/4" OD, Universal Types

KVAL P/N: SMCAS2302F



Speed Controller, 1/4 NPT - 5/16" OD, Universal Types, NAS 2301F-N02-09S

KVAL P/N: SMCAS2303F



Speed Controller, In-line, 1/4"

KVAL P/N: SMCAS3002



Speed Controller, 3/8 NPT - 1/4" OD, Right Angle, SMC AS3201F-N03-07S

KVAL P/N: SMCAS3201FN0307S



Speed Controller, 3/8 NPT - 5/16" OD, Right Angle, SMC AS3201F-N03-09S

KVAL P/N: SMCAS3201FN0309S



Speed Controller, 3/8 NPT - 3/8" OD, Right Angle, SMC AS3201F-N03-11S

KVAL P/N: SMCAS3201FN0311S



Speed Controller, In-line, 3/8"

KVAL P/N: SMCAS4003



Speed Controller, In-line, 1/2", SMC, Flow Control

KVAL P/N: SMCAS4004

Air Motor



Air Motor, 4Z231, 56C Face Flange Mount

KVAL P/N: DAY4Z231F

Blow off



Photo Eye Blowoff Kit

KVAL P/N: 90F3-003



Air Hose



Hose, 1/4-ID Push Lok Gray Air Hose
KVAL P/N: PAR80014



Hose, 3/8-ID Push Lok Gray Air Hose
KVAL P/N: PAR80016



Hose, 1/2-ID Push Lok Gray Air Hose
KVAL P/N: PAR80018



Parflex, E-43, 11/64" ID X 1/4" OD X .40 Wall, Clear Tube, 1 Box (500 Ft)
KVAL P/N: PARE43500

Parflex

- E series natural and colored tubing listed below meet FDA, NSF-51 and NSF-61 requirements for food contact applications.
- Economical.
- Resistant to environmental stress cracking. It greatly exceeds that of ordinary polyethylene tubing as measured by ASTM D-1693 (10% IGEPAL).
- Black (EB) tubing contains an ultraviolet inhibitor which is recommended for use in sunlit areas and in close proximity to high ultraviolet light sources.
- Available in black as well as nine other colors, as recommended by the Instrument Society of America.
- Chemically resistant and flexible.
- Extruded from high molecular weight resin for increased dimensional stability, uniformity and long-term strength.
- All tubing conforms to ASTM D-1248, Type I, Class A, Category 4, Grade E5.



Parflex, E-53, 5/16" O.D. X .062" Wall, Natural Poly Tubing
KVAL P/N: PARE053



Parflex, E-64, 1/4"-ID X 3/8"-OD X.062 Wall Natural Poly Tube
KVAL P/N: PARE064



Parflex, E-86, 3/8-ID 1/2-OD .062 Wall, Natural Poly Tubing
KVAL P/N: PARE086N



Parflex, E-108, 1/2"-ID 5/8"-OD .062" Wall, Polyethylene Tubing
KVAL P/N: PARE108



Tubing, Polyurathane Tubing, 1/4" OD, Clear Color
KVAL P/N: SMCTIUB07C-100FT



Tubing, Polyurathane Tubing, 3/8" OD, Clear Color
KVAL P/N: SMCTIUB11C-100FT



Tubing, Polyurathane Tubing, 5/32" OD, 4mm (5/32"), Clear Color
KVAL P/N: SMCTU0425C-100FT

SMC Polyurethane Tubing Stands the Test of Time

SMC uses Polyether type resin, the highest quality available, to insure the longest possible tube life. There are two resins that are generally used to make Polyurethane, Polyether and Polyester. SMC has chosen Polyether resin because of it's immunity to hydrolysis.





Coil Air Hose



Air Hose, 5 Bonded Coiled Hose,
10 FT, Tube 1/4", With 8" Tails,
Stacked Configuration

KVAL P/N: BUCM29720



Air Hose, 2 Bonded Coiled Hose,
11 FT, Tube .375 OD X .245 ID,
With 8" Tails

KVAL P/N: BUCM31405



Air Hose, 2 Bonded Coiled Hose,
6 FT, Tube .375 OD X .245 ID,
With 8" Tails

KVAL P/N: BUCM31508



Air Hose, 1/4" ID X 12', Blue, With
1/4 NPT Swivel Fittings, Nycoil

KVAL P/N: NYC14410

Pushbuttons & Switches



Mushroom Button, IDEC, Black

KVAL P/N: ABD3BNB



Mushroom Button, IDEC, Green

KVAL P/N: ABD3BNG



Mushroom Button, IDEC, Red

KVAL P/N: ABD3BNR



Mushroom Button, IDEC, Blue

KVAL P/N: ABD3BNS



Mushroom Button, IDEC, Yellow

KVAL P/N: ABD3BNY



Mushroom Operator, IDEC, With no

KVAL P/N: ABDMUSHRM



Push Button Assembly, Start
(6 Shooter Air Controlled)

KVAL P/N: SS211ALAG



Push Button Assembly, Release
(6 Shooter Air Controlled)

KVAL P/N: SS211ALAY

Clevis & Mounting Brackets - 120 Series



Cylinder, Advance 120 Series Clevis

KVAL P/N: ADV120M01



Cylinder, Advance, Hardware, 120 Series, Clevis Double w/Pin & Snap Rings

KVAL P/N: ADV120M02



Cylinder, Advance, Hardware, 120 Series, Clevis Eye Mount, Single

KVAL P/N: ADV120M03



Cylinder, Advance, Hardware, 120 Series, Pin & Snap Rings

KVAL P/N: ADV120M04

Clevis & Mounting Brackets - 240 Series



Cylinder, Advance, Hardware, 240 & 300 Series, Clevis

KVAL P/N: ADV240M01



Cylinder, Advance, Hardware, 240 Series, Clevis Double Mount With Pin & Snap Rings.

KVAL P/N: ADV240M02



Cylinder, Advance, Hardware, 240 Series, Clevis Eye Mount,

KVAL P/N: ADV240M03



Cylinder, Advance, Hardware, 240 Series, Pin & Snap Rings

KVAL P/N: ADV240M04

Clevis & Mounting Brackets - 300 Series



Cylinder, Advance, Hardware, 240 & 300 Series, Clevis

KVAL P/N: ADV240M01



Cylinder, Advance, Hardware, 300 Series, Clevis Double Mount W/ Pin and Snap Rings

KVAL P/N: ADV300M02



Cylinder, Advance, Hardware, 300 Series, Clevis Single Mount

KVAL P/N: ADV300M03



Cylinder, Advance, Hardware, 300 Series, Pin & Snap Rings

KVAL P/N: ADV300M04

Clevis & Mounting Brackets - 490 Series



Cylinder, Advance, Hardware, 490 Series, Clevis

KVAL P/N: ADV490M01



Cylinder, Advance, Hardware, 490 Series, Clevis Double Mount With Pin & Snap Rings

KVAL P/N: ADV490M02



Cylinder, Advance, Hardware, 490 Series, Clevis Single Mount

KVAL P/N: ADV490M03



Cylinder, Advance, Hardware, 490 Series, Pin & Snap Rings

KVAL P/N: ADV490M04



Mounting Brackets - 700 Series



Cylinder, Advance, Hardware, 700 Series, Clevis Double Mount With Pin & Snap Rings

KVAL P/N: ADV700M02



Cylinder, Advance, Hardware, 700 Series, Clevis Single Mount

KVAL P/N: ADV700M03

Clevis & Mounting Brackets - 960 Series



Cylinder, Advance, Hardware, 960 Series, Clevis

KVAL P/N: ADV960M01



Cylinder, Advance, Hardware, 960 Series, Clevis Double Mount With Pin & Snap Rings.

KVAL P/N: ADV960M02



Cylinder, Advance, Hardware, 960 Series, Clevis Eye Mount, Single

KVAL P/N: ADV960M03



Cylinder, Advance, Hardware, 960 Series, Pin & Snap Rings

KVAL P/N: ADV960M04

Clevis & Mounting Brackets - 1600 Series



Cylinder, Advance, Hardware, 1600 Series, Clevis Double Mount With Pin & Snap Rings.

KVAL P/N: ADVP00M02



Cylinder, Advance, Hardware, 1600 Series, Clevis Eye Mount, Single

KVAL P/N: ADVP00M03



Advance Cylinder Repair Kit - Air



Cylinder, Advance, Repair Kit, Air, 120 Series

KVAL P/N: ADV120M05



Cylinder, Advance, Repair Kit, Air, 120 Series, Double Cushion

KVAL P/N: ADV120M08



Cylinder, Advance, Repair Kit, Air, 240 Series

KVAL P/N: ADV240M05



Cylinder, Advance, Repair Kit, Air, 300 Series

KVAL P/N: ADV300M05



Cylinder, Advance, Repair Kit, Air, 490 Series

KVAL P/N: ADV490M05



Cylinder, Advance, Repair Kit, Air, 700 Series

KVAL P/N: ADV700M05



Cylinder, Advance, Repair Kit, I Series, 3-1/4

KVAL P/N: ADV8DAM05



Cylinder, Advance, Repair Kit, 960 Series

KVAL P/N: ADV960M05

Advance Cylinder Repair Kit - Hydraulic



Cylinder, Advance, Repair Kit, Hydraulic, 120 Series

KVAL P/N: ADV120M06



Cylinder, Advance, Repair Kit, 1600 Series

KVAL P/N: ADVP00M05



Cylinder, Advance, Repair Kit, Hydraulic, 240 Series

KVAL P/N: ADV240M06



Cylinder, Advance, Repair Kit, Hydraulic, 300 Series

KVAL P/N: ADV300M06



Cylinder, Advance, Repair Kit, Hydraulic, 490 Series

KVAL P/N: ADV490M06



Cylinder, Advance, Repair Kit, Hydraulic, 960 Series

KVAL P/N: ADV960M06

Advance—Double Cushion 120 Series



Cylinder, Advance, Double Cushion, 120 X 7"

KVAL P/N: ADV120A5X



Cylinder, Advance, Double Cushion, 120 X 8"

KVAL P/N: ADV120A5Z



Cylinder, Advance, Double Cushion, 120 X 9"

KVAL P/N: ADV120A62

Advance—Double Cushion 240 Series



Cylinder, Advance, Double Cushion, 240 X 24"

KVAL P/N: ADV240A6K



Cylinder, Advance, Double Cushion, 240 X 30" (990-FX)

KVAL P/N: ADV240A6Q

Advance—Double Cushion 490 Series



Cylinder, Advance, Double Cushion, 490 X 8"

KVAL P/N: ADV490A5Z



Cylinder, Advance, Double Cushion, 490 X 10"

KVAL P/N: ADV490A64

Advance—Double Rod Ends



ADV240A1G-DRE	Cylinder, Advance 240 x 3 Double Rod Ends
ADV240A1R-DRE	Cylinder, Advance 240 x 5 Double Rod Ends
ADV240A24-DRE	Cylinder, Advance 240 x 10 Double Rod Ends (Acrobat)
ADV490A1B-DRE	Cylinder, Advance 490 x 2 Double Rod Ends (990-FX)
ADV490A1K-DRE	Cylinder, Advance 490 x 4 Double Rod Ends (990-FX)



Advance—Hydraulic 120 Series



ADV120H18	Cylinder, Advance, Hydraulic, 120 X 1-1/4"
ADV120H1B	Cylinder, Advance, Hydraulic, 120 X 2"
ADV120H1Z	Cylinder, Advance, Hydraulic, 120 X 8"
ADV120H22	Cylinder, Advance, Hydraulic, 120 X 9"

Advance—Hydraulic 240 Series



Cylinder, Advance, Hydraulic, 240 X 3"

KVAL P/N: ADV240H1D



Cylinder, Advance, Hydraulic, 240 X 4"

KVAL P/N: ADV240H1K

Advance—Hydraulic 300 Series



ADV300H1C	Cylinder, Advance, Hydraulic, 300 X 3-1/2"
ADV300H1G	Cylinder, Advance, Hydraulic, 300 X 3"
ADV300H1K	Cylinder, Advance, Hydraulic, 300 X 4"
ADV300H1V	Cylinder, Advance, Hydraulic, 300 X 6"
ADV300H1W	Cylinder, Advance, Hydraulic, 300 X 7"

Advance—Hydraulic 490 Series



ADV490H1E	Cylinder, Advance, Hydraulic, 490 X 2"
ADV490H1G	Cylinder, Advance, Hydraulic, 490 X 3"
ADV490H1K	Cylinder, Advance, Hydraulic, 490 X 4"
ADV490H1R	Cylinder, Advance, Hydraulic, 490 X 5" KVAL Backsection
ADV490H1X	Cylinder, Advance, Hydraulic, 490 X 7"

Advance—Rear Cushion 240 Series



Cylinder, Advance, Rear Cushion,
240 X 6"

KVAL P/N: ADV240A7V



Cylinder, Advance, Rear Cushion,
240 X 8"

KVAL P/N: ADV240A7Z

Advance—Rear Cushion 490 Series



Cylinder, Advance, Rear Cushion,
490 X 8"

KVAL P/N: ADV490A82



Cylinder, Advance, Rear Cushion,
490 X 10"

KVAL P/N: ADV490A84



Advance, 490 X 12" Rear Cushion &
Seals 2" Stop Tube. (10" Effective
Stroke) ON-3, OPT R (Door Rotate)

KVAL P/N: ADV490A86

Advance—Standard 120 Series



ADV120A12	Cylinder, Advance, 120 X 15/32"
ADV120A13	Cylinder, Advance, 120 X 1/2"
ADV120A17	Cylinder, Advance, 120 X 1"
ADV120A18	Cylinder, Advance, 120 X 1-1/4"
ADV120A19	Cylinder, Advance, 120 X 1-1/2"
ADV120A1B	Cylinder, Advance, 120 X 2"
ADV120A1C	Cylinder, Advance, 120 X 2-1/4"
ADV120A1G	Cylinder, Advance, 120 X 3"

ADV120A1I	Cylinder, Advance, 120 X 3-1/2"
ADV120A1K	Cylinder, Advance, 120 X 4"
ADV120A1M	Cylinder, Advance, 120 X 4-1/2"
ADV120A1R	Cylinder, Advance, 120 X 5"
ADV120A1X	Cylinder, Advance, 120 X 7"
ADV120A1Z	Cylinder, Advance, 120 X 8"
ADV120A22	Cylinder, Advance, 120 X 9"
ADV120A28	Cylinder, Advance, 120 X 12"

Advance—Standard 240 Series



ADV240A13	Cylinder, Advance, 240 X 1/2"
ADV240A17	Cylinder, Advance, 240 X 1"
ADV240A18	Cylinder, Advance, 240 X 1-1/4"
ADV240A19	Cylinder, Advance, 240 X 1-1/2"
ADV240A1B	Cylinder, Advance, 240 X 2"
ADV240A1D	Cylinder, Advance, 240 X 2-1/2"
ADV240A1G	Cylinder, Advance, 240 X 3"
ADV240A1H	Cylinder, Advance, 240 X 3-1/2"
ADV240A1K	Cylinder, Advance, 240 X 4"
ADV240A1R	Cylinder, Advance, 240 X 5"

ADV240A1V	Cylinder, Advance, 240 X 6"
ADV240A1X	Cylinder, Advance, 240 X 7"
ADV240A1Z	Cylinder, Advance, 240 X 8"
ADV240A24	Cylinder, Advance, 240 X 10"
ADV240A29	Cylinder, Advance, 240 X 13"
ADV240A2A	Cylinder, Advance, 240 X 14"
ADV240A2B	Cylinder, Advance, 240 X 15"
ADV240A2M	Cylinder, Advance, 240 X 30"
ADV240A2Q	Cylinder, Advance, 240 X 34"



Advance—Standard 300 Series



ADV300A16S	Cylinder, Advance, 300 X 3/4"
ADV300A17	Cylinder, Advance, 300 X 1"
ADV300A18S	Cylinder, Advance, 300 X 1-1/2"
ADV300A1B	Cylinder, Advance, 300 X 2"
ADV300A1G	Cylinder, Advance, 300 X 3"
ADV300A1I	Cylinder, Advance, 300 X 3-1/2"
ADV300A1K	Cylinder, Advance, 300 X 4"
ADV300A1R	Cylinder, Advance, 300 X 5"
ADV300A1T	Cylinder, Advance, 300 X 5-1/2"
ADV300A1V	Cylinder, Advance, 300 X 6"

ADV300A1X	Cylinder, Advance, 300 X 7"
ADV300A1Z	Cylinder, Advance, 300 X 8"
ADV300A22	Cylinder, Advance, 300 X 9"
ADV300A24	Cylinder, Advance, 300 X 10"
ADV300A28	Cylinder, Advance, 300 X 12"
ADV300A30	Cylinder, Advance, 300 X 13"
ADV300A2C	Cylinder, Advance, 300 X 14"
ADV300A2D	Cylinder, Advance, 300 X 16"
ADV300A2DA	Cylinder, Advance, 300 X 17"
ADV300A2E	Cylinder, Advance, 300 X 18"
ADV300A2K	Cylinder, Advance, 300 X 25"
ADV300A2U	Cylinder, Advance, 300 X 38"

Advance—Standard 490 Series



ADV490A15	Cylinder, Advance, 490 X 5/8"
ADV490A17	Cylinder, Advance, 490 X 1"
ADV490A19	Cylinder, Advance, 490 X 1-1/2"
ADV490A1B	Cylinder, Advance, 490 X 2"
ADV490A1C	Cylinder, Advance, 490 X 2-1/2"
ADV490A1G	Cylinder, Advance, 490 X 3"
ADV490A1K	Cylinder, Advance, 490 X 4"
ADV490A1V	Cylinder, Advance, 490 X 6"
ADV490A1Z	Cylinder, Advance, 490 X 8"

ADV490A20	Cylinder, Advance, 490 X 9"
ADV490A24	Cylinder, Advance, 490 X 10"
ADV490A28	Cylinder, Advance, 490 X 12"
ADV490A2B	Cylinder, Advance, 490 X 15"
ADV490A2D	Cylinder, Advance, 490 X 16"
ADV490A2E	Cylinder, Advance, 490 X 17"
ADV490A2G	Cylinder, Advance, 490 X 20"
ADV490A2H	Cylinder, Advance, 490 X 22"
ADV490A2I	Cylinder, Advance, 490 X 23" W/2 Stop Tube 21 EFF Stroke 1 Rod 3/4-10 x 1-1/2
ADV490A2J	Cylinder, Advance, 490 X 24"
ADV490A2K	Cylinder, Advance, 490 X 25"
ADV490A2L	Cylinder, Advance, 490 X 28"

Advance—Standard 700 Series



ADV700A16	Cylinder, Advance, 700 X 1"
ADV700A19	Cylinder, Advance, 700 X 1-1/2"
ADV700A1D	Cylinder, Advance, 700 X 2-1/2"
ADV700A1M	Cylinder, Advance, 700 X 4-1/2"
ADV700A1J	Cylinder, Advance, 700 X 5"
ADV700A1X	Cylinder, Advance, 700 X 7"
ADV700A32	Cylinder, Advance, 700 X 32"
ADV700A42	Cylinder, Advance, 700 X 42"



Advance—Style 3



ADV300A37	Cylinder, Advance, Style #3, 300 X 1"
ADV300A3B	Cylinder, Advance, Style #3, 300 X 2"
ADV490A37	Cylinder, Advance, Style #3, 490 X 1"
ADV490A3B	Cylinder, Advance, Style #3, 490 X 2"
ADV490A3C	Cylinder, Advance, Style #3, 490 X 1"
ADV490A3H	Cylinder, Advance, Style #3, 490 X 8" (990F-3 & F4) 06/00
ADV490A3HXX	Cylinder, Advance, Style #3, 490 X 8" W/Flow Controls & Brass (990F-3, F-4 & FX Vertical Hinge RT

Advance—I series



Advance - Standard & Hydraulic 960 Series



ADV960A17	Cylinder, Advance, 960 X 1 Stroke
ADV960A1B	Cylinder, Advance, 960 X 2 Stroke
ADV960A28	Cylinder, Advance, 960 X 8
ADV960A9Z	Cylinder, Advance, 960 X 12
ADV960H1B	Cylinder, Advance, 960 X 2 Hydraulic (985-B)

**ADVANCE AUTOMATION
CYLINDERS**

Specialists in the manufacture of Air Cylinders.

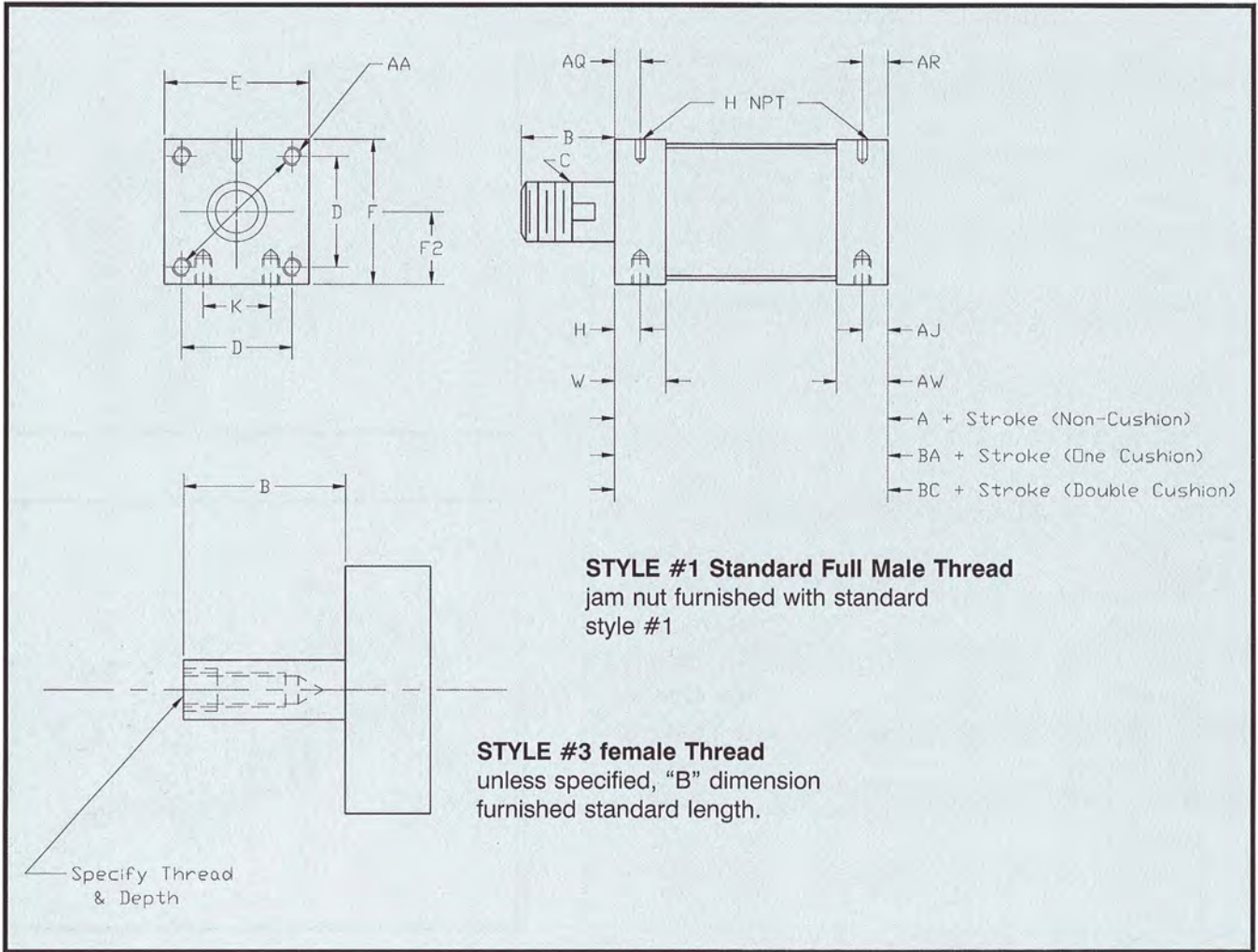

Advance Automation Series B & J Cylinder Dimensions

MODEL	BORE	ROD DIA.	EXTEND POWER MULTIPLE	RETRACT POWER MULTIPLE	A	C CD	E	F	G	J	AA	AG	(1) AH	AO	AP	AR	BA	BC
B120	1 1/4	3/8	1.23	1.12	2 29/32	3/8-16X1	1 13/16	1 13/16	1/4-28X1/4	7/16	1.811	1/4-28X3/8	2 3/16	---	5/16	1/2	3 29/32	4 29/32
B240	1 3/4	3/4	2.40	1.96	3 51/64	3/4-10X1 1/2	2 3/8	2 3/8	5/16-24X3/8	19/32	2.430	5/16-24X1/2	3 1/8	---	5/8	3/4	4 51/64	5 51/64
B300	2	3/4	3.14	2.70	3 51/64	3/4-10X1 1/2	2 3/8	2 3/8	5/16-24X3/8	19/32	2.652	1/4-28X3/8	3 1/8	---	5/8	3/4	4 51/64	5 51/64
B490	2 1/2	3/4	4.91	4.47	3 51/64	3/4-10X1 1/2	2 7/8	2 7/8	5/16-24X9/16	19/32	3.115	5/16-24X1/2	3 5/16	---	5/8	11/16	4 51/64	5 51/64
B700	3	3/4	7.07	6.62	3 51/64	3/4-10X1 1/2	3 3/8	3 3/8	5/16-24X9/16	19/32	3.712	5/16-24X1/2	3 5/16	---	5/8	11/16	4 51/64	5 51/64
B960	3 1/2	1	9.62	8.84	4 35/64	1-8X1 5/8	4	4 1/8	3/8-24X11/16	23/32	4.552	3/8-24X11/16	3 15/16	---	7/8	27/32	5 35/64	6 35/64
B1600	4 1/2	1	15.90	15.12	4 35/64	1-8X1 5/8	5	5 1/8	1/2-20X11/16	23/32	5.701	1/2-20X11/16	3 15/16	---	7/8	27/32	5 35/64	6 35/64
B1960	5	1	19.63	18.85	4 51/64	1-8X1 5/8	5 1/2	5 1/2	1/2-20X11/16	3/4	5.798	1/2-20X11/16	3 15/16	---	7/8	27/32	5 35/64	6 51/64
J2800	6	1 1/2	28.27	26.50	5 3/4	1 1/4-12X1 5/8	6 1/2	6 1/2	1/2-20X5/8	1 1/4	6.894	1/2-20X1/2	3 7/8	2	1 1/4	3/4	---	---
J5000	8	1 1/2	50.26	48.50	5 3/4	1 1/4-12X1 5/8	8 1/2	8 1/2	5/8-18X3/4	1 1/4	9.108	5/8-18X1/2	3 7/8	2	1 1/4	3/4	---	---

(1) AH dimension is minimum distance from cylinder face to centerline of rod clevis pin.

Fabco Mounting Hardware



Cylinder, Fabco Pancake, Hardware, 121-1D Pivot Mount For 121 Series

KVAL P/N: FAB1211D



Cylinder, Fabco, Hardware, 221-1D, Pivot Mount For 221 Series

KVAL P/N: FAB2211D



Cylinder, Fabco Pancake, Hardware, RC-31 Rod Clevis For 121 Series

KVAL P/N: FABRC31



Cylinder, Fabco Pancake, Hardware, RC-38, Rod Clevis For 221 Series

KVAL P/N: FABRC38



Original Series

General, Standard Specifications

Media Air Optional - Hydraulic
 Maximum operating pressure 250 psi Optional - 500 psi
 Minimum operating pressure See page 1.4, Item 4
 Ambient & media temperature -25° to + 250°F
 Prelubrication Magnalube®-G Grease
 Air line lubrication Recommended
 Stroke tolerance ± 1/64"

Pancake® 121 Series



Cylinder, Fabco Pancake C-121-X
1/4 Stroke, 1-1/8 Bore

KVAL P/N: FABC121X



Cylinder, Fabco Pancake D-121-X
1/2 Stroke, 1-1/8 Bore

KVAL P/N: FABD121X



Cylinder, Fabco Pancake E-121-X
1" Stroke, 1-1/8 Bore

KVAL P/N: FABE121X



Cylinder, Fabco Pancake Modified
E-121-X 15/32 Stroke, 1-1/8 Bore

KVAL P/N: FABE121XG



Cylinder, Fabco Pancake Modified
E-121-X 15/16 Stroke, 1-1/8 Bore

KVAL P/N: FABE121XY



Cylinder, Fabco Pancake F-121-X
1-1/4 Stroke, 1-1/8 Bore

KVAL P/N: FABF121X



Cylinder, Stroke Pancake G-121-X
1-1/2 Cylinder, Bore Fabco 1-1/8.

KVAL P/N: FABG121X



Cylinder, Fabco Pancake H-121-X
1-3/4 Stroke, 1-1/8 Bore

KVAL P/N: FABH121X



Cylinder, Fabco Pancake I-121-X
2" Stroke, 1-1/8 Bore

KVAL P/N: FAB121X



Cylinder, Fabco Pancake J-121-X 3
Stroke, 1-1/8 Bore

KVAL P/N: FABJ121X



Cylinder, Fabco Pancake K-121-X 4
Stroke, 1-1/8 Bore

KVAL P/N: FABK121X



Cylinder, Stroke Pancake X-121-X
3/4 1-1/8 Bore Fabco.

KVAL P/N: FABX121X

Pancake 221 Series



Cylinder, Fabco Pancake A-221-X
1/4 Stroke, 1-5/8 Bore

KVAL P/N: FAB221X



Cylinder, Fabco Pancake B-221-X
1/2 Stroke, 1-5/8 Bore

KVAL P/N: FAB221X



Cylinder, Fabco Pancake C-221-X
3/4 Stroke, 1-5/8 Bore

KVAL P/N: FAB221X



Cylinder, Fabco Pancake D-221-X,
1 Stroke, 1-5/8 Bore

KVAL P/N: FAB221X



Cylinder, Fabco Pancake E-221-X
1-1/2 Stroke, 1-5/8 Bore

KVAL P/N: FAB221X



Cylinder, Stroke Pancake F-221-X 2
Cylinder, Bore Fabco 1-5/8.

KVAL P/N: FAB221X



Cylinder, Stroke Pancake G-221-X 3
Cylinder, Bore Fabco 1-5/8

KVAL P/N: FAB221X



Cylinder, Fabco Pancake H-221-X
4 Stroke, 1-5/8 Bore

KVAL P/N: FAB221X

Pancake 321 Series



Cylinder, Fabco, 321-5, 5" Stroke,
2" Bore Round Head Circular end
Mount

KVAL P/N: FAB321-5



Cylinder, Fabco, 321-7, 7" Stroke,
2" Bore Round Head Circular end
Mount

KVAL P/N: FAB3217



Cylinder, Fabco, 321-8, 8" Stroke, 2"
Bore Round Head Circular end
Mount

KVAL P/N: FAB3218



Cylinder, Fabco Pancake F-321-X 2
Stroke, 2 Bore With 1/4 Ports

KVAL P/N: FAB321XP14

Pancake 521 Series



Cylinder, Fabco Pancake E-521-X
2 Stroke, 2-1/2 Bore

KVAL P/N: FABE521XP14



Cylinder, Fabco Modified
E521XP14 1-7/8 Stroke.

KVAL P/N: FABE521XP14XX-A



Cylinder, Fabco Pancake EF-521-X
2-1/2 Stroke, 2-1/2 Bore

KVAL P/N: FABEF521XP14



Cylinder, Fabco Pancake F-521-X 3
Stroke, 2-1/2 Bore With 1/4 Ports

KVAL P/N: FABF521XP14

Pancake 721 Series



Cylinder, Fabco, 721-5, 5" Stroke,
3" Bore Round Head Circular end
Mount

KVAL P/N: FAB721-5



Cylinder, Fabco Pancake Modified
A-721-X to 5/16 Stroke, 3 Bore.
Use (2) TRC-1220.

KVAL P/N: FABA721XM



Cylinder, Fabco Pancake G-721-X
4 Stroke, 3 Bore

KVAL P/N: FABG721X

Fabco Repair Kits



Cylinder, Fabco Pancake RK-121
Repair Kit - 121 Series

KVAL P/N: FABRK121



Cylinder, Fabco Pancake RK-221
Repair Kit - 221 Series

KVAL P/N: FABRK221



Cylinder, Fabco, Repair Kit, LS-321-
RK Long Stroke

KVAL P/N: FABRK321-LS



Cylinder, Fabco Pancake RK-521
Repair Kit 521 Series

KVAL P/N: FABRK521



Cylinder, Fabco Pancake RK-721
Repair Kit 721 Series, SK721

KVAL P/N: FABRK721



Bimba Single Acting

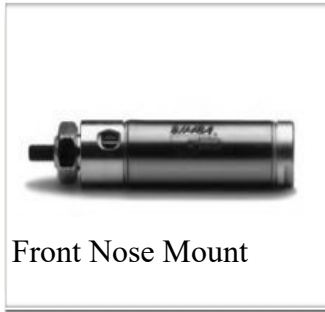

Front Nose Mount

BIM042	Cylinder, Bimba 042, 2" Single Acting Front Nose Mount 3/4 Bore.	BIM095	Cylinder, Bimba 095 5" Single Acting Front Nose Mount 1-1/16 Bore.
BIM091	Cylinder, Bimba 091 1" Single Acting Front Nose Mount 1-1/16 Bore.	BIM096	Cylinder, Bimba 096 6" Single Acting Front Nose Mount 1-1/16 Bore.
BIM091.5D	Cylinder, Bimba 091.5D 1-1/2" Single Acting Front Nose Mount 1-1/16 Bore.	BIM121	Cylinder, Bimba 121 1" Single Acting Front Nose Mount 1-1/4 Bore.
BIM092	Cylinder, Bimba 092 2" Single Acting Front Nose Mount 1-1/16 Bore	BIM123	Cylinder, Bimba 123 3" Single Acting Front Nose Mount 1-1/4 Bore.
BIM092NR	Cylinder, Bimba 092NR 2" Single Acting Front Nose Mount Non-Rotating 1-1/16 Bore.	BIM123NR	Cylinder, Bimba 123NR 3" Single Acting Front Nose Mount Non-Rotating 1-1/4 Bore.
BIM094	Cylinder, Bimba 094 4" Single Acting Front Nose Mount 1-1/16 Bore.	BIM125NR	Cylinder, Bimba 125NR 5" Single Acting Front Nose Mount Non-Rotating 1-1/4 Bore.

Double Acting 7/16" Bore



Double Acting 3/4" Bore



Double Acting 7/8" Bore



To see our full line of products,

go to kvalinc.com and type

Bimba

Find

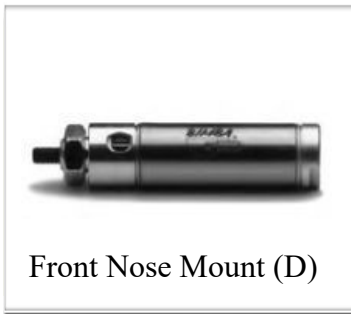
Double Acting 1-1/16" Bore

Front Nose Mount (D)



Double End Rod Mount (DXD)



Rear Pivot Mount (DP)

BIM090UD	Cylinder, Bimba 090.5D 1/2 Double Acting Front Nose Mount 1-1/16 Bore
BIM091D	Cylinder, Bimba 091D 1" Double Acting Front Nose Mount 1-1/16 Bore.
BIM091DP	Cylinder, Bimba 091DP 1" Double Acting Rear Pivot Mount 1-1/16 Bore.
BIM091DXD	Cylinder, Bimba 091DXDE 1" Double Acting Double End Rod Mount 1-1/16 Bore.
BIM092D	Cylinder, Bimba 092D 2" Double Acting Front Nose Mount 1-1/16 Bore.
BIM092DP	Cylinder, Bimba 092DP 2" Double Acting Rear Pivot Mount 1-1/16 Bore.
BIM092DXD	Cylinder, Bimba 092DXDE 2" Double Acting Double End Rod Mount 1-1/16 Bore.
BIM093D	Cylinder, Bimba 093D 3" Double Acting Front Nose Mount 1-1/16 Bore.

BIM093DP	Cylinder, Bimba 093DP 3" Double Acting Rear Pivot Mount 1-1/16 Bore.
BIM094DP	Cylinder, Bimba 094DP 4" Double Acting Rear Pivot Mount 1-1/16 Bore.
BIM095D	Cylinder, Bimba 095D 5" Double Acting Front Nose Mount 1-1/16 Bore
BIM096D	Cylinder, Bimba 096D 6" Double Acting Front Nose Mount 1-1/16 Bore

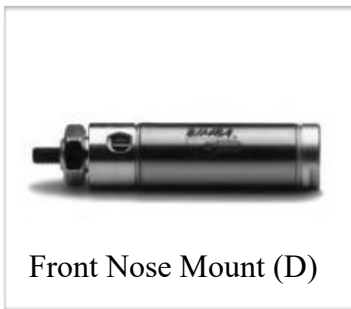
Double Acting 1-1/4" Bore

Front Nose Mount (D)

BIM120UDP	Cylinder, Bimba 120.5DP 1-1/4" Double Acting Rear Pivot Double End Mount 1-1/4 Bore.
BIM121.5DP	Cylinder, Bimba 121.5 DP 1-1/2" Double Acting Rear Pivot Double End Mount 1-1/4 Bore
BIM121D	Cylinder, Bimba 121D 1" Double Acting Front Nose Mount 1-1/4 Bore.
BIM121DP	Cylinder, Bimba 121DP 1" Double Acting Rear Pivot Double End Mount 1-1/4 Bore.
BIM122D	Cylinder, Bimba 122D 2" Double Acting Front Nose Mount 1-1/4 Bore.
BIM122DP	Cylinder, Bimba 122DP 2" Double Acting Rear Pivot Double End Mount 1-1/4 Bore.
BIM123D	Cylinder, Bimba 123D 3" Double Acting Front Nose Mount 1-1/4 Bore.
BIM123DP	Cylinder, Bimba 123DP 3" Double Acting Rear Pivot Double End Mount 1-1/4 Bore.



Double Acting 1-1/4" Bore

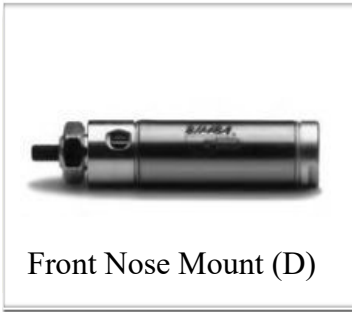

Front Nose Mount (D)

BIM120UDP	Cylinder, Bimba 120.5DP 1-1/4" Double Acting Rear Pivot Double End Mount 1-1/4 Bore.
BIM121.5DP	Cylinder, Bimba 121.5 DP 1-1/2" Double Acting Rear Pivot Double End Mount 1-1/4 Bore
BIM121D	Cylinder, Bimba 121D 1" Double Acting Front Nose Mount 1-1/4 Bore.
BIM121DP	Cylinder, Bimba 121DP 1" Double Acting Rear Pivot Double End Mount 1-1/4 Bore.
BIM122D	Cylinder, Bimba 122D 2" Double Acting Front Nose Mount 1-1/4 Bore.
BIM122DP	Cylinder, Bimba 122DP 2" Double Acting Rear Pivot Double End Mount 1-1/4 Bore.
BIM123D	Cylinder, Bimba 123D 3" Double Acting Front Nose Mount 1-1/4 Bore.
BIM123DP	Cylinder, Bimba 123DP 3" Double Acting Rear Pivot Double End Mount 1-1/4 Bore.

Double Acting 1-1/4" Bore



Rear Pivot Mount (DP)

BIM124D	Cylinder, Bimba 124D 4" Double Acting Front Nose Mount 1-1/4 Bore.
BIM124DP	Cylinder, Bimba 124DP 4" Double Acting Rear Pivot Double End Mount 1-1/4 Bore.
BIM125D	Cylinder, Bimba 125D 5" Double Acting Front Nose Mount 1-1/4 Bore.
BIM125DP	Cylinder, Bimba 125DP 5" Double Acting Rear Pivot Double End Mount 1-1/4 Bore.
BIM126DP	Cylinder, Bimba 126DP 6" Double Acting Rear Pivot Double End Mount 1-1/4 Bore.
BIM128DP	Cylinder, Bimba 128DP 8" Double Acting Rear Pivot Double End Mount 1-1/4 Bore.
BIM129DP	Cylinder, Bimba 129DP 9" Double Acting Double End Rod Mount 1-1/4 Bore.
BIM1212DP	Cylinder, Bimba 1212DP 12" Double Acting Rear Pivot Double End Mount 1-1/4 Bore

Double Acting 1-1/2" Bore



Double End Rod Mount (DXD)

BIM172D	Cylinder, Bimba 172D 2" Double Acting Front Nose Mount 1-1/2 Bore.
BIM173D	Cylinder, Bimba 173D 3" Double Acting Front Nose Mount 1-1/2 Bore.
BIM173DX	Cylinder, Bimba 173DX 3" Double Acting Double End Mount 1-1/2 Bore.
BIM175D	Cylinder, Bimba 175D 5" Double Acting Front Nose Mount 1-1/2 Bore.

To see our full line of products,

go to kvalinc.com and type

Bimba

Find

AIR

AIR

Double Acting 1-3/4" Bore



Front Nose Mount (D)



Double End Rod Mount (DXD)



Rear Pivot Mount (DP)

BIM241D	Cylinder, Bimba 241D 1" Double Acting Front Nose Mount 1-3/4 Bore (1/2-20 THD).
BIM241DP	Cylinder, Bimba 241DP 1" Double Acting Rear Pivot Double End Mount 1-3/4 Bore.
BIM241DXD	Cylinder, Bimba 241DXDE 1" Double Acting Double End Rod Mount 1-3/4 Bore.
BIM242D	Cylinder, Bimba 242D 2" Double Acting Front Nose Mount 1-3/4 Bore (1/2-20 THD).
BIM242DP	Cylinder, Bimba 242DP 2" Double Acting Rear Pivot Mount 1-3/4 Bore
BIM242DXD	Cylinder, Bimba 242DXDE 2" Double Acting Double End Rod Mount 1-3/4 Bore
BIM243DP	Cylinder, Bimba 243DP 3" Double Acting Rear Pivot Double End Mount 1-3/4 Bore.
BIM244.5DP	Cylinder, Bimba 244DP 4-1/2" Double Acting Rear Pivot, Double End Mount 1-3/4 Bore

BIM244D	Cylinder, Bimba 244D 4" Double Acting Front Nose Mount 1-3/4 Bore.
BIM245DP	Cylinder Bimba 245DP 5" Double Acting Rear Pivot Double End Mount 1-3/4 Bore.
BIM245DXD	Cylinder, Bimba 245DXDE 5" Double Acting Double End Rod Mount (YR 2007 990-H)
BIM246DP	Cylinder, Bimba 246DP 6" Double Acting Rear Pivot Double End Mount.
BIM249DP	Cylinder, Bimba 249DP 9" Double Acting Rear Pivot Double End Mount.
BIM2412DP	Cylinder, Bimba 2412DP, 12" Stroke, 1-3/4" Bore Double Acting Double End Mount.
BIM2414DP	Cylinder, Bimba 2414DP 14" Double Acting Rear Pivot Double End Mount 1-3/4" Bore.
BIM2416DP	Cylinder, Bimba 2416DP 16" Double Acting Rear Pivot Double End Mount 1-3/4" Bore.

BIM2418DP	Cylinder, Bimba 2418DP 18" Double Acting Rear Pivot Double End Mount 1-3/4" Bore.
BIM2420DP	Cylinder, Bimba 2420DP 20" Double Acting Rear Pivot Double End Mount 1-3/4" Bore.
BIM2422DP	Cylinder, Bimba 2422DP 22" Double Acting Double End Mount 1-3/4 Bore.
BIM2424DP	Cylinder, Bimba 2424DP 24" Double Acting Double End Mount 1-3/4 Bore. (1/2-20 Thread)



Double Acting 2" Bore



Cylinder, Bimba 3120DXP.

KVAL P/N: **BIM3120DXP**

BIM311	Cylinder, Bimba, 311 1 Single Acting Front Nose Mount, 2" Bore
BIM3120DXP	Cylinder, Bimba, 3120DXP, 20" Stroke, Double Acting Rear Pivot Mount, 2" Bore. Used on Acrobat
BIM3121DXP	Cylinder, Bimba, 3121DXP, 21" Stroke, Double Acting Rear Pivot Mount, 2" Bore. Used on Acrobat
BIM312D	Cylinder, Bimba, 312D 2 Double Acting Front Nose Mount, 2" Bore
BIM313DXP	Cylinder, Bimba, 313DXP 3" Stroke, Double Acting Rear Pivot Mount, 2" Bore. Used on Acrobat
BIM314D	Cylinder, Bimba, 314D Double Acting Front Nose Mount, 2" Bore.

Double Acting 2-1/2" Bore



Cylinder, Bimba 501D 1" Double Acting Front Nose Mount 2-1/2 Bore

KVAL P/N: **BIM501D**



Cylinder, Bimba 501D 2" Double Acting Front Nose Mount 2-1/2 Bore

KVAL P/N: **BIM502D**

Hydraulic Cylinders



Cylinder, Bimba Hydraulic H314DBZ 4" Double Acting Front Block Mount, 2" Bore

KVAL P/N: **BIMH314DBZ**



Cylinder, Bimba Hydraulic H315DBZ 5" Double Acting Front Block Mount, 2" Bore

KVAL P/N: **BIMH315DB**



Cylinder, Bimba Hydraulic H176DUZ 6" Stroke with Poly Pack Seals Double Acting 1-1/2" Bore

KVAL P/N: **BIMH78129-A-6**



Magnetic Bimba Cylinders



Rear Pivot Mount
(DP & DXP)



Front Nose Mount (D)

BIM-M091-D	Bimba M-091-D Cylinder With Magnet
BIM-M122DP	Bimba M122DP Cylinder With Magnet
BIM-M123-DP	Bimba M123DP Cylinder With Magnet
BIM-M123.5-DP	Bimba M123.5-DP Cylinder With Magnet
BIM-M124DP	Bimba M124DP Cylinder With Magnet

BIM-M125DP	Bimba M125DP Cylinder With Magnet
BIM-M126-DP	Bimba M126-DP Cylinder With Magnet
BIM-M127D	Bimba M127-D Cylinder With Magnet
BIM-M171.875-1.875D	Bimba M171.875/1.875-D 3 Position Cylinder With Magnet
BIM-M172DNR	Bimba M-172 DNR 2 Double Acting Front Nose Mount Non Rotating, With Magnet, 1-1/2 Bore

BIM-M2415DP	Bimba M243-DP Cylinder With Magnet
BIM-M243DP	Bimba M126-DP Cylinder With Magnet
BIM-M244-DP	Bimba M244-DP Cylinder With Magnet
BIM-M247DP	Bimba M247-DP 7 Double Acting Rear Pivot Double End Mount With Magnet
BIM-M3111D	Bimba M-3111-D Cylinder With Magnet

BIM-HLM247DP	Bimba HLM-247-DP Hydraulic Cylinder With Magnet
BIMMRS-092-DXP	Bimba MRS-092 DXP Cylinder With Magnet
BIMMRS-094-DXP	Bimba MRS-094 DXP Cylinder With Magnet
BIMMRS-096-DXP	Bimba MRS-096 DXP Cylinder With Magnet

Block Mount Single Acting



Cylinder, Bimba BF-090.5, 1/2" Stroke, Single Acting Front Block Mount, 1-1/16 Bore.

KVAL P/N: **BIMBF0905**

Block Mount Double-Acting



Cylinder, Bimba BF171D 1" Double Acting Front Block Mount 1-1/2 Bore.

KVAL P/N: **BIMBF171D**



Cylinder, Bimba BF172D 2 Double Acting Front Block Mount 1-1/2 Bore.

KVAL P/N: **BIMBF172D**



Bimba Mounting Accessories



Cylinder Hardware, Bimba 240 Foot Mount Bracket 1.037 Bore, 3" Long Slotted Base

KVAL P/N: **BIMC1337**



Cylinder, Bimba, Hardware, 040,050,090 Foot Mount Bracket, .620 Bore, 1.88 Long Slotted Base

KVAL P/N: **BIMD129**



Cylinder Hardware, Bimba, 040,060,090, 2-PC Pivot Bracket, .250 Pin, 2.00 Long Slotted Base

KVAL P/N: **BIMD13498**



Cylinder, Bimba, Hardware, 2 Piece Pivot Bracket, .250 Bore 2.12 Slotted Base

KVAL P/N: **BIMD1360**



Cylinder Hardware, Clevis 090 Series 5/16-24 National Fine Thread 1.19 Long .25 Diameter Pin

KVAL P/N: **BIMD1661**



Cylinder, Bimba, Hardware, Clevis 120, 170, 7/16-20 NF, 1.69 Long, .38 Pin

KVAL P/N: **BIMD2311**



Clevis, 240, 310, 050, Hardware, 1/2-20 National Fine Thread 1.69 Long .38 Pin, Bimba Cylinder Bracket

KVAL P/N: **BIMD2313**



Cylinder, Bimba, Hardware, 120, 170 Foot Bracket .75 Bore 2.50

KVAL P/N: **BIMD241**



Cylinder, Bimba, Hardware, 500 Series, Mounting Nut 1-3/8-12 NF

KVAL P/N: **BIMD2540**



Cylinder, Bimba, Hardware, 2" & 2-1/2" Bore Cylinder, 2-Piece Pivot Bracket .375 Pin 3.00 Long Slotted Base

KVAL P/N: **BIMD620**



Cylinder, Bimba, Hardware, 2-Piece Pivot Bracket .375 Pin 2.88 Long

KVAL P/N: **BIMD6201**



Cylinder, Bimba, Hardware, 010, 020 Double Acting Mounting Bracket, .44 Bore, 1.38 Long Slotted Base

KVAL P/N: **BIMD770**



Cylinder Hardware, Bimba, Clevis, 170, 7-16-20 NF Thread, 2.00 Long, .375 Pin

KVAL P/N: **BIMD8311A**



Cylinder, Bimba, Hardware, 170 Foot Bracket, 1.00 Bore, 2.38 Long Slotted Base

KVAL P/N: **BIMD8317**

To see our full line of products,

go to kvalinc.com and type

Cable cylinders

Find

Cable Cylinders



Cylinder, Cable Greenco CD1538A 38 Stroke 1-1/2 Bore Double End Rodless Cable Cylinder (555 OPTE)

KVAL P/N: GRECD1538



Cylinder, Repair Kit Greenco CD2026A 39-7/8"

KVAL P/N: GRECD2026-RK

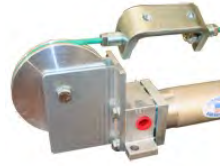

Cylinder, Cable Greenco Cable-Trol, CD2038A

KVAL P/N: GRECD2038



Cylinder, Cable Repair Kit, Greenco, for CD2045 58-7/8"

KVAL P/N: GRECD2045-RK



Cylinder, Cable Repair Kit, Green-co, for CD2047A, Seals Only

KVAL P/N: GRECD2047A-SS



Cylinder, Cable Greenco Cable-Trol, CD2047, Used on Handler Carriage

KVAL P/N: GRECD2047M



Cylinder, Cable Repair Kit, Green-co, for CD2047 (61-1/4")

KVAL P/N: GRECD2047-RK

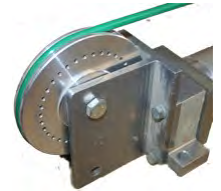

Cylinder, Modified Cable Greenco Cable-Trol, CD 3226, Modified End Pulley and Housing to accommodate Photo Emitter and Receiver

KVAL P/N: GRECD3226M



Repair Kit For the Greenco Cable Cylinder, CD3226A (43-1/2")

KVAL P/N: GRECD3226-RK



Cylinder, Cable Greenco Cable-Trol, 100 Stroke 200 Series (Handler Dual-Stack)

KVAL P/N: GRECD20100



Repair Kit for Greenco Cable-Trol, 100 Stroke 200 Series (Handler Dual-Stack)

KVAL P/N: GRECD20100-RK



Caliper, Disc Air Brake, 1/2" Thick Disc, TOL-O-MATIC

KVAL P/N: TOLP20DER



Cable Cylinder 56 Stroke (Tolomatic 200-3) (ON-2)

KVAL P/N: TOL200354



Cylinder, Cable Repair Kit (1024-9002 56 Stroke)

KVAL P/N: TOL1024



Cable Cylinder 90 Stroke (Tolomatic 200-3) (ON-3D)

KVAL P/N: TOL200390



Cylinder, Cable Repair Kit 90 Stroke

KVAL P/N: TOLRKCC30SK90



Cylinder Assemblies

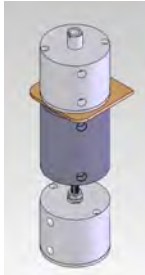

Cylinder, Stack Assembly, Vertical Hinge Router. Includes Brass Guides and Flow Controls. D221X 15/32" Stroke, D221X 15/16" Stroke, F221X 1-7/8" Stroke (Architect)

KVAL P/N: 31-00-34

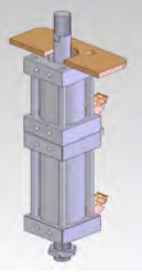

777 Screwdriver Head, Cylinder Assembly For Head. Includes 1 ADV240A1B (240X2) & 1 ADV240A1K (240X4) W/ Brass Guide Installed (777)

KVAL P/N: 76-00-49



Cylinder, Stack Assembly, Horizontal, ADV 490 X 10 RC & ADV 490 X

KVAL P/N: 90F12913A



Cylinder, Stack Assembly, Vertical, 120 X 1-1/4 & 1-7/8 With Flow Controls (990-E, 990F & 990F-2)

KVAL P/N: 90F13626-A



Horizontal RTR Shift Cylinder Assy (300x5 & 300x16 With Brass Slides & FC'S (990RCD & RE)

KVAL P/N: 99RCD004



Cylinder Assembly 120 X 1 & 120 X 3 With Flow Controls (Raise Door) (888)

KVAL P/N: ADV120A1H



Cylinder, Assembly, Horizontal Back Section, Side Bore, ADV490 X 7 Hydraulic & ADV490 X 8 DC, With Flow Controls (990-RE, 990-RCD, 990F & F-2)

KVAL P/N: ADV490A5Y



Cylinder, Nose to Nose 240 700-C Feed Wheel Movement Springville Double. Nose/1.25 - Nose 2.375.

KVAL P/N: BUC02634



Cylinder, Stack Assembly, Vertical, 990F-3 Hinge Section, With Flow Controls & Brass Fittings (990F-3 & 4)

KVAL P/N: FAB-A001



Cylinder, Stack Assembly, 950-3, 5/8 Radius, With Flow Controls & Brass, Fabco F-121X 1-1/4 & X121X 3/4

KVAL P/N: FAB-A002A



Cylinder, Fabco, Stack Assembly, Commander Hinge Section, With Flow Controls & Brass, 221 Series

KVAL P/N: FAB-A003



Cylinder, Stack Assembly, 960-3 - 121 Series, With Flow Controls & Brass. (960-3, 950-3 & 950-4)

KVAL P/N: FAB-A004



Cylinder Assembly, 960-3, Option D, Closed Plate, 1 FAB121X 3/4" Stroke & FABE121X 1" Stroke W/ Flow Controls & Connecting Rod

KVAL P/N: FAB-A004C



Cylinder, Fabco, Stack Assembly, 990F-3, Hinge Section, (1) E221XX 1-1/4, (1) F221XX 1-7/8 With Brass & Flow Controls (990F-3 & F4)

KVAL P/N: FAB-A006



Cylinder, Fabco, Stack Assembly, DL-2 Cutterhead Post 1996, (1) A721 5/16" Stroke & (1) 721-5 5" Stroke With Brass Guide & Flow Controls (DL-2)

KVAL P/N: FAB-A007A



Cylinder, Stack Assembly, Vertical, 990F-3 and 990F-4 Front Hinge Section

KVAL P/N: FAB-A009



Cylinder Assemblies continued



Cylinder, Assembly, Front, 1-1/4 & 1-7/8, Used on 990F-3, F-4 and FX (Use for FAB-A009)

KVAL P/N: FAB-A009B



Advance Cylinder, B490 X 8 Style #2 B=1 27/64 C= 1/2 -20 X 43/64, (Use for FAB-A009)

KVAL P/N: ADV490X-A009



1/4 - 5/8 Radius Vertical Stack Assembly. Includes Fabco 521 Series & Advance Cylinder W/ Flow Controls & Brass Spacers. Used on 990F-3 & 4.

KVAL P/N: FAB-A013



Cylinder, Assembly, Vertical Hinge Stack. W/ Flow Controls, Used on 990F-3 & 4. (1-13/16, 15/32, 15/16 & 11/32)

KVAL P/N: FAB-A013A

Bimba Repair Kit



Cylinder, Bimba, Repair Kit, With O-Ring, K-B-FO-50

KVAL P/N: BIM-K-B-FO-50



Cylinder, Bimba, Repair Kit, With U-Cup Seals, K-B-FO-50-L

KVAL P/N: BIM-K-B-FO-50-L

Humphrey Valve & Accessories



Air Piloted Valve, Humphrey 125A-3-10-20, Normally Closed, 1/8" (3.2mm) Orifice, 3-Way Pilot.

KVAL P/N: HUM125A01



Air Piloted Valve, Humphrey 125A-3-11-20 Normally Open, 1/8" (3.2mm) Orifice, 3-Way Pilot.

KVAL P/N: HUM125A02



Air Piloted Valve, Humphrey 250A-3-10-20, Normally Closed 1/4" (6.4mm), 3-Way Pilot

KVAL P/N: HUM250A01



Air Piloted Valve, Humphrey 250A-3-11-20, Normally Open, 1/4" (6.4mm) orifice, 3-Way Pilot.

KVAL P/N: HUM250A02



Valve, Humphrey, Hardware, Toggle Lever for 41TDS3 & 41TS3

KVAL P/N: HUM31200A



Valve, Humphrey, Air Piloted 501A-3-12-20, 1/2 Ports, 275 CFM AT 125 PSI 2&3WAY,N/0&C

KVAL P/N: HUM501A



Toggle/Rocker Air Valves



Valve, Humphrey, 2 or 3-Way Normally Closed/ Normally Open, Spring Return.

KVAL P/N: HUM31P



Valve, Humphrey, 3-Way Normally Closed Toggle.

KVAL P/N: HUM31V



Valve, Humphrey, 3P Spring Return Normally Closed.

KVAL P/N: HUM3P



Valve, Humphrey, 3-Way Toggle 2-Position Normally Closed, Detented Valve.

KVAL P/N: HUM3V



Valve, Humphrey, 4-Way Normally Closed/ Normally Open 5-Port, Spring Return.

KVAL P/N: HUM41P



Valve, Humphrey, 4-Way Normally Closed/ Normally Open 5-Port, Detente.

KVAL P/N: HUM41PP



Valve, Humphrey, 4-Way Rocker 3-Position, Detented Valve

KVAL P/N: HUM41RD3



Valve, Humphrey, 4-Way Rocker 3-Position, Detented Valve, Spring Return.

KVAL P/N: HUM41RDS3



Valve, Humphrey, 4-Way Rocker 3-Position, Spring Return.

KVAL P/N: HUM41RS3



Valve, Humphrey, 4-Way Toggle 3-Position, Detented Valve.

KVAL P/N: HUM41TD3



Valve, Humphrey, 4-Way Toggle 3-Position, Detented Valve, Spring Return.

KVAL P/N: HUM41TDS3



Valve, Humphrey, 4-Way Toggle 3-Position Spring Return.

KVAL P/N: HUM41TS3



Valve, Humphrey, 4-Way Normally Closed/Normally Open 2-Position

KVAL P/N: HUM41V



Valve, Humphrey, 4-Way Toggle 2-Position Normally Closed/Normally Open, Detented Valve

KVAL P/N: HUM4V

To see our full line of products,

go to kvalinc.com and type

Humphrey

Find

Humphrey Fittings



Valve, Humphrey, Fitting, 10-32" Barbed to 1/4" ID Hose.

KVAL P/N: **HUMBF1**



Valve, Humphrey, Fitting, Elbow 10-32 1 Male - 2 Female

KVAL P/N: **HUMUEF**



Valve, Humphrey, 3P Spring Return Normally Closed.

KVAL P/N: **HUMUTF**

Humphrey Mounting Brackets



Valve, Humphrey, Hardware, 8-20A Mounting Base for HUM250A01 & HUM250A02

KVAL P/N: **HUM820A**



Valve, Humphrey, TAC Valve, Hardware, 8-600 Angle Bracket Single

KVAL P/N: **HUM8600**

Operators



Valve, Humphrey Cam Operator 3/32 Stroke.

KVAL P/N: **HUM34C**



Valve, Humphrey Cam Operator Heavy Duty.

KVAL P/N: **HUM34CH**



Valve, Humphrey Cam Operator 1-Way Trip.

KVAL P/N: **HUM34CW**

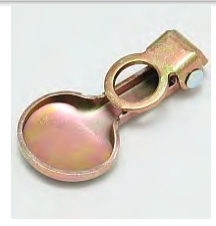

Valve, Humphrey, Operator Fingertip 1/4 Min 3/8 Max Movement

KVAL P/N: **HUM34T**

Hydraulic Reservoir



Reservoir Hydraulic, Monnier, 2-1000 (977) (6 Inches in Height)

KVAL P/N: **MON21000**



Reservoir Hydraulic, Monnier, 2-1750 (10 Inches in Height)

KVAL P/N: **MON21750**



Pneumatic Air/Oil Reservoir, 2-1750, Bowl and Gaskets Kit for Monnier Reservoir, 3-3/8" O.D.

KVAL P/N: **MON24555**

Filters



Drain, 1/2" Drip Leg Automatic Drain,
(SMC NAD402-N04)

KVAL P/N: SMCNAD402N04



1/4 Mini Air Filter NAF 2000-N02 (1/8
Body With 1/4 Ports) or AF20-N02-CZ
Substitute for: SMC20001F

KVAL P/N: SMCAF20-N02-CZ-A



Filter, 1/4" With Auto Drain, SMC
AF30-N02D-Z-A
Substitute for: SMC20002F

KVAL P/N: SMCAF30N02DZA



Filter, 1/2" With Auto Drain
Substitute for: SMC40004F

KVAL P/N: SMCAF40N04DZA



Mist Generator, Used On DLNCA &
555 Cutterhead (Mist Oiler)(3922B)

KVAL P/N: WAL3922B



Mist Oiler Filter, 1/4 NPT, SMC
NAL430-N02B

KVAL P/N: SMCNAL430



Lubricators



1/4 Mini Lubricator NAL 2000-NO2G
or AL20-N02-3CZ (1/8 Body with 1/4
Ports) SMC Filter

Substitute for: SMC20001L

KVAL P/N: SMCAL20-N02-3Z-A



1/4 Lubricator AL30-NO2-3Z-A SMC
Filter

Substitute for: SMC20002L

KVAL P/N: SMCAL30N023ZA



Lubricator, 1/2 " NPT Port
(AL40-N04-Z-A)

Substitute for: SMC40004L

KVAL P/N: SMCAL40N04ZA



Lubricator Sight Glass, Used on
2000,3000 & 4000 Series, SMC
Filter

KVAL P/N: SMCAL20P-080AS



Lubricator Filler Plug, 1/2, SMC

KVAL P/N: SMCAL40P-06AS



Edge Auto Lubricator Replacement
Cartridge for 125-BGO-0101KSS for
the 125CM Version (Edge Rack &
Pinion) (Must Be Replaced Yearly)

KVAL P/N: WIT20021556

Regulators



1/4 Mini Regulator with Check Valve & Built In Gauge (AR20K-NO2EH-Z-B) (1/8 Body with 1/4 Ports)

Substitute for: **REGG04MINI**

KVAL P/N: **SMCAR20K-N02EH-Z-B**



1/4 Regulator AR30K-N02H-Z-B (Use with K-10 Gauge) SMC Filter. (With Internal Check Valve)

Substitute for: **SMC20002R-K**

KVAL P/N: **SMCAR30KN02HZB**



Regulator, 1/2 NPT Port (AR40K-NO4E-Z-B) (With Built in Gauge)

Substitute for: **SMC40004R-K**

KVAL P/N: **SMCAR40K-N04E-Z-B**



Air Regulator with Gauge Moisture Separator and Dump

KVAL P/N: **WAL7936**



1/2 Regulator Bracket SMC. (AR40P-270AS)

KVAL P/N: **SMC40004N**



Regulator, 1/2 NPT Port (AR40K-NO4-Z-B) (Use with K-10 Gauge)

Substitute for: **SMC40004R**

KVAL P/N: **SMCAR40K-N04-Z-B**



Regulator, 1" NPT Port (AR60-N10-Z)

KVAL P/N: **SMCAR60N10Z**

SMC Pressure Gauges



Pressure Gauge, SMC, K40, 1/8 NPT Thread. Use on Mini, 1/4 & 1/2 Regulators, 160 PSI

KVAL P/N: **SMCK10**



Pressure Gauge, SMC, K50, 1/4 NPT Thread, 160 PSI Use Only on Regulator # **SMC40004R**

KVAL P/N: **SMCK12**



Pressure Gauge, SMC, K40, 1/8 NPT Thread, 30 PSI, K40-MPO.2-N01MS

KVAL P/N: **SMCK20**

SMC Blank & Pigtails



Pigtail, For SMC Valve VQZ2151-5LO, 1 Meter, 24V, AXT661-14A-10

KVAL P/N: **SMCAXT66114A**



Pigtail 40 For NZ SMC Valve Mini Valve, 110V

KVAL P/N: **SMCNZ440P**



Valve, Blanking Kit, SMC

KVAL P/N: **SMCVVQ4000-10A-1**



SMC Mini Solenoid Valves



120 Volt AC Coil VQZ2150-3M1
Single Acting (Mini) SMC Valve Uses
SY100-30-3A-20 OR SY100-30-3A-10
Cable (PN: SMCVQZ1000U-85-1A)
Substitute for: SMCNZ4101
KVAL P/N: SMCVQZ2150-3M1



24 Volt DC Coil VQZ2150-5LJ1 Single
Acting (Mini) SMC Valve, With Pigtail
Conversion Adapter Included. Uses AXT661
Style Cable with Conversion Adapter or Uses
SY100 Cable without Conversion Adapter
Substitute for: SMCVQZ21505LO
KVAL P/N: SMCVQZ21505LJ1



Valve, 120 Volt AC Coil, Single
Acting, VQZ2151-3YZW, Mini, SMC
Valve With Mini DIN-ISO Plug
KVAL P/N: SMCVQZ21513YZW



24 Volt DC Coil VQZ2251-5LJ1 Double
Acting (Mini) SMC Valve, With Pigtail
Conversion Adapter Included. Uses AXT661
Style Cable with Conversion Adapter or Uses
SY100 Cable without Conversion Adapter
Substitute for: SMCVQZ22515LO
KVAL P/N: SMCVQZ22515LJ1

SMC & Mac Solenoid 4-Way Valve—Single Acting

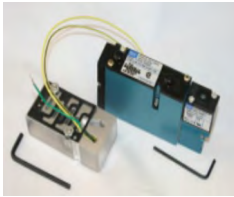

Single Valve and Adapter Plate ASSY,
120V, 4 Way Single Acting (SMC
MFG P/N NVS4114 Replacement)
Substitute for: SMCNVS401
KVAL P/N: MAC-92-SINGLE-120V-NVS



Valve, VQC4100-51 SMC Valve
without Base, Single Acting, 24 VDC
Substitute for: SMCVQC4100-5
KVAL P/N: SMCVQC4100-51



4 Way 5Port With Base, Metal Seals, 120
Volt Coil SMC Valve.
Substitute for: SMCVQ5100-3W-04T
KVAL P/N: SMCVQ5100-3W1-04T



Valve, VQC4100-51 & VQ4000
SMC Valve With 1/4 NPT Base,
Single Acting
KVAL P/N: SMCVQC4100-5A



Valve, SMC Repair Kit For
NVS4114-0009D Solenoid.
KVAL P/N: SMCNVS99

SMC & Mac Solenoid 4-Way Valve—Double Acting



Double Valve and Adapter Plate
ASSY, 120V, 4 Way Double Acting
(SMC NVS4214 Replacement)
Substitute for: SMCNVS403
KVAL P/N: MAC-92-DOUBLE-120V-NVS



VQC4200-51 SMC Valve Without
Base, Double Acting, 24VDC
Substitute for: SMCVQC4200-5
KVAL P/N: SMCVQC4200-51

SMC 3 Way Valve



Valve, SMC 3-Way, NAV 4000-
N04-3D 1/2, Soft Start
KVAL P/N: SMCNAV4000N043D

SMC Solenoid 4-Way Valve—Triple Acting

Solenoid Valves



Valve, VQC4300-5 SMC, Without Base, Triple Acting, 24 VDC

KVAL P/N: SMCVQC4300-5



V53DB2150 Valve 1/4 3-Way/ Use 7000 Series) (Skinner 71315SN2EN-J1NOC111P3) (Used On Handler)

Substitute for: PREB30241

KVAL P/N: SKIV53DB2

Fabco Air Valves



Directional Control Valve, Fabco 18 Series, PMD-3, 1/8" NPT, 3-WAY, Detented (Push-Pull), Panel Mount Button

KVAL P/N: FAB18PMD3



Valve, Fabco, Repair Kit, 1800-943, Spool With O-Rings, For Push Pull Valve

KVAL P/N: FAB18PMD3-RK



Directional Control Valve, Fabco 18 Series, PMD-4, 1/8" NPT, 4-WAY, Detented (Push-Pull), Panel Mount Button

KVAL P/N: FAB18PMD4



Valve, Fabco, Repair Kit, 1800-944, Spool With O-Rings, For Push Pull Valve

KVAL P/N: FAB18PMD4-RK



Valve, Fabco, 3-Way Single 18 PMS-3 1/8.

KVAL P/N: FAB18PMS3



Valve, Fabco, Repair Kit, 1800-903, Spool With O-Rings, For Spring Return Valve

KVAL P/N: FAB18PMS3-RK



Valve, Fabco, 1800 PMS-4 1/8, 4 Way Single 18 Series Palm Button Actuated

KVAL P/N: FAB18PMS4



Valve, Fabco, Repair Kit, 1800-904, Spool With O-Rings, For Spring Return Valve

KVAL P/N: FAB18PMS4-RK

Mac Electric Valve & Valve Bank



End Plate Kit for 9200 Series Valve Bank 92B-000-BJG

KVAL P/N: MAC-92-ENDPLATE



For 120 Volt Valves, Manifold Station 92 Series 1/4" NPT

KVAL P/N: MAC-92-120V-MANIFOLD250



For 120 Volt Valves, Manifold Station 92 Series 3/8" NPT

KVAL P/N: MAC-92-120V-MANIFOLD375



Single Valve, MAC Valve 92B-AAB-000-DM-DJAP-1DG 120V AC (SMC NVS4114 Replacement)

KVAL P/N: MAC-92-SINGLE-120V-VALVE



Double Valve, MAC Valve 92B-BAB-000-DM-DJAP-1DG 120V AC (SMC NVS4214 Replacement)

KVAL P/N: MAC-92-DOUBLE-120V-VALVE

Mac Air Piloted Valves



4-Way Single Air Pilot Valve, MAC 180001-112-0003 Without Base, (SMC NVSA4114-000 Alternate)
Substitute for: **SMCNVSA01**

KVAL P/N: MAC-AIR-SINGLE



4-Way Double Air Pilot Valve MAC 180003-112-0003 Without Base, (SMC NVSA4214-000 Alternate)
Substitute for: **SMCNVSA04**

KVAL P/N: MAC-AIR-DOUBLE



3 Position, Closed Center Air Pilot Valve MAC 180304-512-0304 (SMC NVSA4314 Alternate)
Substitute for: **SMCNVSA07**

KVAL P/N: MAC-AIR-3POSCLOSEDCENTER

Please note that with the new MAC air valves you will not need to use the base. Discard the old SMC base and attach valve to the frame of the machine.

Manifolds



Parker Manifold 2-3/8 OD Tube 4-1/4 OD Tube

KVAL P/N: PAR24M-6-4



Union Branch 1/4 OD X 5 Connections

KVAL P/N: PNE-CPUB250



Union Branch 3/8 OD X 5 Connections

KVAL P/N: PNE-CPUB375



Exhaust Dump Valve



Valve ,Quick Exhaust Dump Valve, 1/8", OR12B

KVAL P/N: SCH364101



Quick Exhaust Dump Valve 1/4 "(3640-1000)(OR-25B Parker) (950-3)

KVAL P/N: SCH364001

Foot Valves



Foot Valve, E212TM, 1/4 Ports 4-Way Manual (Treadle) Manual

KVAL P/N: AROE212TM



Treadle Foot Valve, Parker, 53093-100, 1/4 NPT, Direct air 6" Series Valves 4-Way, 5-Port, 2-Position, Operated Detented

KVAL P/N: SCH530931



Air Valve Foot Switch 4 Way Maintained (Push On Push Off) Alternate Action With Guard

KVAL P/N: MFDM4F21008LG

Limit Valves



Air Valve, 1/8 Cam Follower, With Roller Arm, OCLA4-1

KVAL P/N: NUMOCLA41



Air Valve, 1/4 Cam Follower, With Roller Arm, OCLA4-2

KVAL P/N: NUMOCLA42

Sleeve Valves



Sleeve Valve, 1/8", 3-Way

KVAL P/N: FOS3W125



Sleeve Valve, 1/4", 3-Way

KVAL P/N: FOS3W250



Sleeve Valve, 3/8", 3-Way

KVAL P/N: FOS3W375



Sleeve Valve, 1/2", 3-Way

KVAL P/N: FOS3W500

Vacuum



Filter, Arrow, In-Line Vacuum Filter, 25 Micron, 9052-25

KVAL P/N: ARR905225



Air, Vacuum Generator, #Z-019, No Gauge, No Silencer

KVAL P/N: NORZ019



Arrow EK9052-25 Vacuum Air Filter Repair Kit (Cartridge & Gasket)

KVAL P/N: AEK905225

Shuttle Valves



Shuttle Valve, 1/8", SV10B, NPT

KVAL P/N: DELSV10B



Shuttle Valve, 1/4", SV20B, NPT

KVAL P/N: DELSV20B

Oneshot Valve



Valve, Fabco, OS-1, One Shot (Pulse)

KVAL P/N: FABOS1

Digital Pressure Switch



Air, SMC, High Precision Digital Pressure Switch, ISE40

KVAL P/N: SMCISE40T122L

Nozzle



Air Nozzle, UniJet Blow-off nozzle, 1/8 Male Thread, .023in Slot Width

KVAL P/N: SPRAY-125

Vacuum Gauge



VACUUM GAUGE 50MM WorkSmart - 2 Inch Dial, 1/4 Inch NPT, 30 to 0 Scale Range Pressure Gauge ABS Case, Brass Wetted Parts, Bronze Bourdon Tube, Lower Connection Mount, 30 to 0 Display Range

KVAL P/N: WSPEGAUGE20



Mufflers

Mufflers Should Be Cleaned or Replaced Once a Year.



Air, Muffler, 3/8" Silencer, For Gast Air Motor

KVAL P/N: FABM60-03



Air, Muffler, 1/2" NPT, For Gast Air Motor, AC-990

KVAL P/N: MUFFAC990



Air, Muffler, 3/8" NPT, For Gast Air Motor, AC-995

KVAL P/N: MUFFAC995



Air, Muffler, 1/8" NPT Thread, 7/16" Overall Length, 7/16" Hex Head Breather Vent Bronze Screen, BV-1

KVAL P/N: MUFFBV1



Air, Muffler, 1/4" NPT Thread, 5/8" Overall Length, 9/16" Hex Head Breather Vent Bronze Screen, BV-2

KVAL P/N: MUFFBV2



Air, Muffler, 3/8" NPT Thread, 3/4" Overall Length, 11/16" Hex Head Breather Vent Bronze Screen, BV-3

KVAL P/N: MUFFBV3



Air, Muffler, 1/8" Thread, Bronze

KVAL P/N: MUFFLER02



Air, Muffler, 1/4" Thread, Bronze Screen

KVAL P/N: MUFFLER04



Air, Muffler, 3/8" Thread, Bronze Screen

KVAL P/N: MUFFLER06



Air, Muffler, 3/8" NPT, High Flow Exhaust, 4440K123

KVAL P/N: MUFFLER06-HF



Air, Muffler, 1/2" Thread, Bronze

KVAL P/N: MUFFLER08



Air, Muffler, 1/2" NPT, High Flow Exhaust, 4440K124

KVAL P/N: MUFFLER08-HF



Air, Muffler, 3/4" Thread, Bronze Screen

KVAL P/N: MUFFLER12



Cables

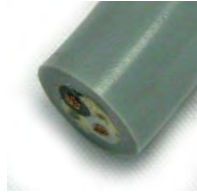

16GA, 2 Wire Cable Gray
Substitute for: **STO162**

KVAL P/N: **SAB2041602**



Cable, 3 Wire, 16GA, 16-3 STO 3,
Gray

KVAL P/N: **STO163**



Cable, 4 Wire, 16GA, 16-4 STO,
Gray

KVAL P/N: **STO164**



Igus Chainflex 16GA Electrical
Cable, 16AWG .51 DIA 12
Conductor

KVAL P/N: **CF130-15-12**

Cord Grip



RSR103-L-R	Cord Grip, Straight, Conduit Size 1/2", Cable Range .125-.188, Aluminum
RSR104-L-R	Cord Grip, Straight, Conduit Size 1/2", Cable Range .188-.250, Aluminum
RSR105-L-R	Cord Grip, Straight, Conduit Size 1/2", Cable Range .250-.312, Aluminum
RSR106-L-R	Cord Grip, Straight, Conduit Size 1/2", Cable Range .312-.375, Aluminum
RSR109-L-R	Cord Grip, Straight, Conduit Size 1/2", Cable Range .500-.562, Aluminum
RSR110-L-R	Cord Grip, Straight, Conduit Size 1/2", Cable Range .562-.625, Aluminum



RSR45103-L-R	Cord Grip, 45 Degree, Conduit Size 1/2", Cable Range .125-.188, Aluminum
RSR45104-L-R	Cord Grip, 45 Degree, Conduit Size 1/2", Cable Range .188-.250, Aluminum
RSR45105-L-R	Cord Grip, 45 Degree, Conduit Size 1/2", Cable Range .250-.312, Aluminum
RSR45106-L-R	Cord Grip, 45 Degree, Conduit Size 1/2", Cable Range .312-.375, Aluminum



RSR9103-L-R	Cord Grip, 90 Degree, Conduit Size 1/2", Cable Range .125-.188, Aluminum
RSR9104-L-R	Cord Grip, 90 Degree, Conduit Size 1/2", Cable Range .188-.250, Aluminum
RSR9105-L-R	Cord Grip, 90 Degree, Conduit Size 1/2", Cable Range .250-.312, Aluminum
RSR9106-L-R	Cord Grip, 90 Degree, Conduit Size 1/2", Cable Range .312-.375, Aluminum
RSR9107-L-R	Cord Grip, 90 Degree, Conduit Size 1/2", Cable Range .375-.438, Aluminum
RSR9108-L-R	Cord Grip, 90 Degree, Conduit Size 1/2", Cable Range .438-.500, Aluminum
RSR9109-L-R	Cord Grip, 90 Degree, Conduit Size 1/2", Cable Range .500-.562, Aluminum

Cord Grip



SRB104	Cord Grip, Bushing, Conduit Size 1/2", Cable Range .188-.250
SRB105	Cord Grip, Bushing, Conduit Size 1/2", Cable Range .250-.312
SRB106	Cord Grip, Bushing, Conduit Size 1/2", Cable Range .312-.375
SRB107	Cord Grip, Bushing, Conduit Size 1/2", Cable Range .375-.438
SRB108	Cord Grip, Bushing, Conduit Size 1/2", Cable Range .438-.500
SRB109	Cord Grip, Bushing, Conduit Size 1/2", Cable Range .500-.562
SRB110	Cord Grip, Bushing, Conduit Size 1/2", Cable Range .562-.625

Plugs



Hubbell, GFST15BK GFCI Receptacle, AutoGuard®, Commercial Self Test, 15A, 125V Black

KVAL P/N: **HBL5661**



Single Receptacle, HUBBELL, 220V, 15A, 5661

KVAL P/N: **HBL5661**



Locking Plug, Leviton, 3 Pole, 20 Amps, 4 Wires, 250 V, 3 Phase, 2421

KVAL P/N: **HUB2421**



Hubbell, 250V, 3 Phase Body, 2423

KVAL P/N: **HUB2423**



Hubbell, Ground Locking Plug-N, 480 Volt, 20 Amps, 2431

KVAL P/N: **HUB2431**



Hubbell, Ground Locking Plug, 240 Volt, 30 Amps, 2721

KVAL P/N: **HUB2721**



Plug, HUBBELL, Locking Plug, 125V, 15A, 4720-C

KVAL P/N: **HUB4720-C**



Duplex Receptacle, HUBBELL, 2 Pole, 3 Wire, 15 Amp, 125 V, 5252

KVAL P/N: **HUB5252**



Plug, HUBBELL, Male, 110 Volt Ground Plug, 5266C

KVAL P/N: **HUB5266C**



Plug, HUBBELL, Female, 110 Volt Ground Plug, 5269C

KVAL P/N: **HUB5269C**



Hubbell, S-7, Wall Plate, Stainless Steel, 1 Gang, 1 Receptacle

KVAL P/N: **HUBS-7**

Counters

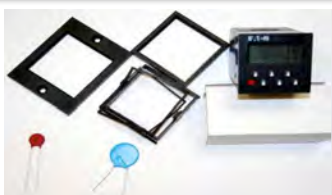

Eaton E5-148-C1400 Programmed As A Count Down Preset With Relay Contact On Or Closed At 0 Count. Includes Installation Instructions Substitute for: RED6X592

KVAL P/N: **E5148C1400PREDOWN-NO**

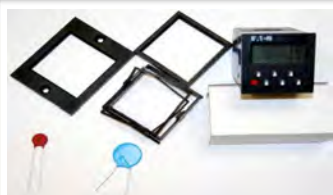

Eaton E5-148-C1400 Programmed As A Count Down Preset With Relay Contact Off Or Open At 0 Count. (Used only on model ON-1 with Omron PLC)

KVAL P/N: **E5148C1400PREDOWN-NC**

Auxiliary Contact



No Aux Contact ABB

KVAL P/N: **OA1G10**



Contactors



Eaton 3Pole Contactor 120 Volt Coil Quick Connect & Screw Terminals for Coil. 30 Amp Inductive Contacts. (Use C320KG1 Aux Contact)
KVAL P/N: C25DNC330A



Contactor, LSIS MC22BAC1205060HZ11S
KVAL P/N: MC-22B-120



LSIS MC22BRAC12022S Reversing Contactor Assembled.
KVAL P/N: MC-22B-120-REVERSING



Contactor, LG, 40 Amps
KVAL P/N: MC-40A-AC120



Contactor, LG, 85 Amps
KVAL P/N: MC-85A-AC120

Disconnect



Disconnect Shaft 6MM, 210MM Long
KVAL P/N: OXP6X210



Disconnect Shaft 6MM, 290MM Long
KVAL P/N: OXP6X290



Disconnect Shaft 6MM Square Shaft 400 MM Long.
KVAL P/N: OXP6X400



ABB Dual Disconnect, 80 AMP, 6 pole
KVAL P/N: OT80F6



Pistol Handle, Red/ Black, Nema 1, 3R, 12 Accepts 6mm SQ Shaft,
KVAL P/N: OHB65J6



Disconnect Switch, 80 Amp, 3 Poles, ABB, OT80F3, 1SCA105798R1001
KVAL P/N: OT80F3



Disconnect, Neutral For OT63E3 & OT80F3
Substitute for: OTPN63EP
KVAL P/N: OTPN80FP



Power Pole For OT63E3 or OT80F
Substitute for OTPS63EP
KVAL P/N: OTPS80FP



To see our full line of products,

go to kvalinc.com and type

Overload

Find

Overload



Thermal Overload Relay, 0.63-1A.
Metasol MC-22b MT-32/3K-0.82S

KVAL P/N: MC-22B-OL-1.0A



Thermal Overload Relay, 1-1.6A,
Metasol MC-22B MT-32/3K-1.3S

KVAL P/N: MC-22B-OL-1.6A



Thermal Overload Relay, 1.6-2.5A.
Metasol MC-22B MT-32/3K-2.1S

KVAL P/N: MC-22B-OL-2.5A



Thermal Overload Relay, 2.5-4.0A.
Metasol MC-22B MT-32/3K-3.3S

KVAL P/N: MC-22B-OL-4A

All Carlo Gavazzi Overloads and Contactors Have Been Replaced by Metasol MC-22B



Thermal Overload Relay, 4-6 A.
Metasol MC-22b MT-32/3K-5S

KVAL P/N: MC-22B-OL-6A



Thermal Overload Relay, 5-8A,
Metasol MC-22b MT-32/3K-6.5S

KVAL P/N: MC-22B-OL-8A



Thermal Overload Relay, 6-9A.
Metasol MC-22b MT-32/3K-7.5

KVAL P/N: MC-22B-OL-9.0A



Thermal Overload Relay, 7-10A,
Metasol MC-22B MT-32/3K-8.5S

KVAL P/N: MC-22B-OL-10A



Thermal Overload Relay, 9A-13A.
Metasol MC-22B MT-32/3K-11S

KVAL P/N: MC-22B-OL-13A



Thermal Overload Relay, 12-18A.
Metasol MC-22b MT-32/3K-15S

KVAL P/N: MC-22B-OL-18A



Thermal Overload Relay, Metasol
MC-40A MT-32/3K-27S

KVAL P/N: MC-40A-OL-27A



Overload Base for Making
Standalone Overload for MT-32
Overloads

KVAL P/N: MC-22B-OL-BASE

All Metasol Overload
Relays Require One
Base, One 12 or 5 inch
piece of Din-rail and
Two Din-rail Stops

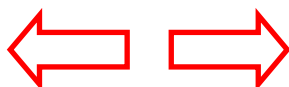

Din Rail



Din Rail, 12 Inch Long, Low Profile
Perforated, PHEONIX 0801733

KVAL P/N: DINRAIL-12



DIN Rail, End Clips, 9.5MM low
profile

KVAL P/N: DIN-RAIL-STOP

Indicator Lights & Lamps



LED Pilot Light Lens, IDEC, 16mm Rectangular, Warm White, AL6H-LK2

KVAL P/N: AL6H-LK2-W



IDEC, 16mm Rectangular Illuminated Push Button, 24VDC, Red LED Bulb & Red Lens

KVAL P/N: AL6H-M14P-R



LED Pilot Light Operator Base, IDEC, 16mm Rectangular Illuminated

KVAL P/N: AL6H-P00



Neon Indicator Light with .187 Quick Connect Terminals Industrial Devices

KVAL P/N: IDI-1050QC4



Light, Indicator Industrial Devices, Green, 24V DC, 1091QM5

KVAL P/N: IDI-1091QM5-24



Chicago Miniature 120V Neon Amber Indicator, 6010QM3

KVAL P/N: IDI-6010QM3



Light, Chicago Miniature 24V Green Led Indicator, 6091QM5-24

KVAL P/N: IDI-6091QM5-24



Bulb, For Illuminated operators, 6.3 Volts, Indicator Light KM1 Square D module

KVAL P/N: LAMP755



Bulb, For Illuminated operators, 24VDC, Indicator Light KM35

KVAL P/N: LAMP757

Light Module



Standard Light Module, 24 VDC, 30mm, Square D, 9001-KM35

KVAL P/N: KM35



LAPD-2-A	Bulb, For Illuminated operators, 6.3 Volts,
LAPD-2-G	Light, Indicator Industrial Devices, Green, 24V DC, 1091QM5
LAPD-2-R	Chicago Miniature 120V Neon Amber Indicator, 6010QM3
LAPD-2-W	Light, Chicago Miniature 24V Green Led Indicator, 6091QM5-24
LAPD-2-Y	Neon Indicator Light with .187 Quick Connect Terminals Industrial Devices



Relays



Relay, FINDER,
34.51.7.024.0010, 24VDC, SPDT
Interface Relay

KVAL P/N: 345170240010



Relay Interface Module, FINDER,
38.51.7.024.0050, 24VDC

KVAL P/N: 385170240050



Relay, FINDER, General Purpose
Relay, 55.34.8.120.0050, 4PDT,
120 V AC Coil (50/60Hz), 7A, 14
Pin

KVAL P/N: 55.34.8.1200050



Finder 3PDT 120V 11 Pin Relay
Indicator Light Button

KVAL P/N: 60.13-RELAY



Finder Flange Mount Relay 3PDT
16A/250V Contacts 1/4" Quick

KVAL P/N: 62.83.8.120.000



FINDER Relay Socket 94.04 For
Relay Type 55.34.

KVAL P/N: 94.04



(Sensor Relay 15) Shaft Stop Control
Relay - Model CAF15 (+24Vdc).

KVAL P/N: COLCAF15



Relay, Interface Module IM-T-9A,
BANNER

KVAL P/N: IM-T-9A



Pistol Handle, Red/ Black, Nema
1, 3R, 12 Accepts 6mm SQ Shaft,

KVAL P/N: RH1B-ULDC24V

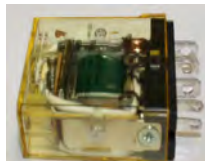

IDEC MIDGET POWER RELAY
(RH2B-U-AC120V)

KVAL P/N: RH2BUAC120V



RV3T-1G05 Relay for Opennet

KVAL P/N: RV3T-1G05



Idec Socket Relay Mount for RH1B-
ULDC24V Relay

KVAL P/N: SH1B-05



Relay Socket, SR2P05 2PDT, 8
Pin Screw, Track Mount

KVAL P/N: SR2P05



Relay Socket, SR3P05 3PDT, 11
Pin Screw, Track Mount, 10A,
300V

KVAL P/N: SR3P05

MicroSmart FC4A & FC5A



PLC, Microsmart, 16 Relay Output Module

KVAL P/N: FC4AR161



PLC, Microsmart, 8 Input, 24 VDC Module

KVAL P/N: FC4AN08B1



PLC, Microsmart, 16 Input, 24 VDC Module

KVAL P/N: FC4AN16B1



PLC, Microsmart, 8 Relay Output Module

KVAL P/N: FC4AR081



IDEC CPU PENTRA

KVAL P/N: FC5A-C24R2



IDEC Pentra 12 I/O CPU w / Ethernet

KVAL P/N: FC5A-D12K1E



IDEC Pentra 16 I/O CPU SLIM-LINE

KVAL P/N: FC5A-D16RK1



IDEC,FC5A Series, Expansion RS232C Communication Module, FC5A-SIF2, Microsmart Pentra

KVAL P/N: FC5A-SIF2

MicroSmart FC6A



Idec 16IO CPU (POST 2016)

KVAL P/N: FC6A-C16R1CE



Idec 24IO CPU (PRE 2016)

KVAL P/N: FC6A-C24R1AE



FC6A 8 Input, 24 VDC Module

KVAL P/N: FC6AN08B1



FC6A 16 Input, 24 VDC Module

KVAL P/N: FC6AN16B1



FC6A 8 Relay Output Module

KVAL P/N: FC6A-AR081



FC6A 16 Output Module

KVAL P/N: FC6AR161



Power Supply



Power Supply, PLC, 24V DC, 1.3 Amps,
Input: 100-240, 30 Watts, IDEC

KVAL P/N: PS5R-SC24



Power Supply, PLC, 24V DC, 3.75
Amps, Input: 100-240, 90 Watts, IDEC,
PS5R-SE24

KVAL P/N: PS5R-SE24



5V DC 2.5 AMPS IDEC POWER SUP-
PLY INPUT: 100-240 15WATT after
2/5/17 new part number PS5R-VB05

KVAL P/N: PS5R-B05

Encoders



Encoder, 716 400 Pulse High Voltage
Line Driver Output 3/8 Double
Shaft, Encoder Products 716-0400-
HV-S-6-D-S-Y.

KVAL P/N: EPC716-400-HV



Encoder, 716 400 Pulse High
Voltage Line Driver Output 1/4
Single Shaft, Encoder Products
716-0400-HV-S-4-D-S-Y.

KVAL P/N: EPC716-400-HV-.25



Encoder, Spur Gear, 1-1/2 Dia.
Use with AG32P1 Fine Pitch
Rack, Modified Bore 3/8

KVAL P/N: G8340

Touchscreen



Idec Color Touch Screen Upgrade. Convert
HG2F to HG2G-5FT22TF-W .Includes
Touch Screen, Adapter Plate, Conversion
Cable and Labor to Reprogram.

Substitute for: HG2F-SS22VF

KVAL P/N: HG2G-UPK

Ethernet Gateway



Ethernet Switch, 8 Port, FL
Switch SFN 8TX, Phoenix
2891929

KVAL P/N: PHOENIX-2891929



ATDR Fuses



ATDR.5	ATDR, Time Fuse Delay, .5 Amp, 600 VAC
ATDR1	ATDR, Time Fuse Delay, 1 Amp, 600 VAC
ATDR1.5	ATDR, Time Fuse Delay, 1.5 Amp, 600 VAC
ATDR2	ATDR, Time Fuse Delay, 2 Amp, 600 VAC
ATDR2.5	ATDR, Time Fuse Delay, 2.5 Amp, 600 VAC
ATDR3	ATDR, Time Fuse Delay, 3 Amp, 600 VAC
ATDR4	ATDR, Time Fuse Delay, 4 Amp, 600 VAC
ATDR5	ATDR, Time Fuse Delay, 5 Amp, 600 VAC
ATDR6	ATDR, Time Fuse Delay, 6 Amp, 600 VAC
ATDR7	ATDR, Time Fuse Delay, 7 Amp, 600 VAC
ATDR8	ATDR, Time Fuse Delay, 8 Amp, 600 VAC
ATDR10	ATDR, Time Fuse Delay, 10 Amp, 600 VAC
ATDR12	ATDR, Time Fuse Delay, 12 Amp, 600 VAC
ATDR15	ATDR, Time Fuse Delay, 15 Amp, 600 VAC
ATDR17.5	ATDR, Time Fuse Delay, 17.5 Amp, 600 VAC
ATDR20	ATDR, Time Fuse Delay, 20 Amp, 600 VAC
ATDR25	ATDR, Time Fuse Delay, 25 Amp, 600 VAC
ATDR30	ATDR, Time Fuse Delay, 30 Amp, 600 VAC

FRNR Fuses



FRNR1A	Fuse, FRN-R, 1 Amp, 250VAC
FRNR2A	Fuse, FRN-R, 2 Amp, 250VAC
FRNR3A	Fuse, FRN-R, 3 Amp, 250VAC
FRNR4A	Fuse, FRN-R, 4 Amp, 250VAC
FRNR5A	Fuse, FRN-R, 5 Amp, 250VAC
FRNR10A	Fuse, FRN-R, 10 Amp, 250VAC
FRNR12A	Fuse, FRN-R, 12 Amp, 250VAC
FRNR15A	Fuse, FRN-R, 15 Amp, 250VAC
FRNR20A	Fuse, FRN-R, 20 Amp, 250VAC
FRNR25A	Fuse, FRN-R, 25 Amp, 250VAC
FRNR30A	Fuse, FRN-R, 30 Amp, 250VAC
FRNR40A	Fuse, FRN-R, 40 Amp, 250VAC
FRNR45A	Fuse, FRN-R, 45 Amp, 250VAC
FRNR60A	Fuse, FRN-R, 60 Amp, 250VAC
FRNR100	Fuse, FRN-R, 100 Amp, 250VAC
FRNR175	Fuse, FRN-R, 175 Amp, 250VAC
FRNR200	Fuse, FRN-R, 200 Amp, 250VAC

Ferraz Shawmut Fuses



A6T15	Fuse, Ferraz 15 AMP 600Volt Class T
A6T20	Fuse, Ferraz 20 AMP 600Volt Class T
A6T30	Fuse, Ferraz 30 AMP 600Volt Class T
A6T60	Fuse, Ferraz 60 AMP 600Volt Class T

FRS-R Fuses



FRSR15A	Fuse, FRS-R 15 AMP 600 VAC 13/16 x 5
FRSR20A	Fuse, FRS-R 20 AMP 600 VAC 13/16 x 5
FRSR30A	Fuse, FRS-R 30 AMP 600 VAC 13/16 x 5
FRSR35A	Fuse, FRS-R 35 AMP 600 VAC 1 1/16 x 5



Beckhoff PLC



Modular Industrial PC, Windows Embedded 7, No TwinCAT, 1.4 GHz Celeron, 2GB DDR3 RAM, 8GB Cfast flash

KVAL P/N: **BEC-CX2020-120**



DIN rail Industrial PC, Windows Embedded Compact 7, No TwinCAT, 1 GHz ARM, 256MB microSD, 1 GB RAM, 128 KB NOVRAM

KVAL P/N: **BEC-CX9020-0110**

Beckhoff Servo Motors



BEC-AM8032-1H10-0000	Beckhoff Servo Motor, Single Cable, 72mm flange, 14mm shaft, 2.37Nm stall. 5.1A continuous
BEC-AM8032-1H20-0000	Beckhoff Servo Motor. Single Cable. multi-turn absolute position within 4096 revolutions. 72mm flange. 14mm shaft. 2.37Nm stall. 5.1A continuous
BEC-AM8532-1H10-0000	Beckhoff High Inertia Servo Motor, Single Cable, 72mm flange, 14mm keyed shaft, 2.37Nm stall. 5.1A continuous
BEC-AM8532-1H20-0000	Beckhoff High Inertia Servo Motor. Single Cable. multi-turn absolute position within 4096 revolutions. 72mm flange. 14mm shaft. 2.37Nm stall. 5.1A continuous
BEC-AM8542-0F10-0000	Beckhoff High Inertia Servo Motor, Single Cable, 87mm flange, 19mm smooth shaft, 4.10Nm stall, 4.10A continuous
BEC-AM8552-1L10-0000	Beckhoff High Inertia Servo Motor, Single Cable, 95mm flange, 24mm keyed shaft, 8.2 Nm stall, 11.3A continuous
BEC-AM8552-1L20-0000	Beckhoff High Inertia Servo Motor, Single Cable. multi-turn absolute position within 4096 revolutions. 95mm flange, 24mm keyed shaft, 8.2 Nm stall, 11.3A continuous

Beckhoff Servo Cables



ZK4530-8110-0150 - Resolver feedback cable for Beckhoff AM8000 series servo motors, 15 meter.

KVAL P/N: **BEC-ZK4530-8110-0150**

Beckhoff Servo Cables



BEC-ZK4500-8022-0080	8 Meter Power Cable for Beckhoff AM802x to AM803x series servo motors, 8 meter.
BEC-ZK4500-8022-0150	8 Meter Power Cable for Beckhoff AM802x to AM803x series servo motors, 15 meter.
BEC-ZK4500-8022-0200	8 Meter Power Cable for Beckhoff AM802x to AM803x series servo motors, 20 meter.



BEC-ZK4500-8023-0080	Power Cable for Beckhoff AM804x to AM806x series servo motors, 8 meter.
BEC-ZK4500-8023-0150	Power Cable for Beckhoff AM804x to AM806x series servo motors, 15 meter.
BEC-ZK4500-8023-0200	Power Cable for Beckhoff AM804x to AM806x series servo motors, 20 meter.
BEC-ZK4500-8023-0250	Power Cable for Beckhoff AM804x to AM806x series servo motors, 25 meter.

Beckhoff Servo Drives



BEC-AX5106-0000	AX5106-0000 Digital compact Servo drive, rated current 6A, 1 Axis drive, 100-480 VAC EtherCAT Interface integrated mains filter
BEC-AX5106-0200	AX5106-0200 Digital compact Servo drive, rated current 6A, 1 Axis drive, 100-480 VAC EtherCAT Interface integrated mains filter
BEC-AX5112-0200	Digital compact Servo drive, rated current 12A, 1 Axis drive, 100-480 VAC EtherCAT Interface integrated mains filter
BEC-AX5206-0200	2 axis compact servo drive, rated current 6A, 100-480 VAC EtherCAT Interface integrated mains filter





Bechhoff Components



TwinSAFE 4-channel digital input terminal for sensors with potential-free contacts for 24 V DC. It meets the requirements of IEC 61508 SIL 3 and DIN EN ISO 13849 PLe

KVAL P/N: **BEC-EL1904**



TwinSAFE 4-channel digital output terminal. It switches 24 VDC, up to 0.5A per channel. It meets the requirements of IEC 61508 SIL 3 and DIN EN ISO 13849 PLe.

KVAL P/N: **BEC-EL2904**



EL4132 Analog Output Terminal, 2 analog outputs +/-10V, single ended, 16 bit

KVAL P/N: **BEC-EL4132**



EL6900 TwinSAFE PLC

KVAL P/N: **BEC-EL6900**



Compact Servo Drive. 50 VDC. 4A. 1 resolver input. 1 digital output for a motor brake 24 V DC

KVAL P/N: **BEC-EL7201**



Up/Down counter, 24V, 1kHz, 32bit

KVAL P/N: **BEC-ES1512**



ES2624 4-channel-relay-output terminal 125 V AC/30 V DC With Terminal Block

KVAL P/N: **BEC-ES2624**



Incremental- Encoder-Interface differential inputs, 16 / 32 bit (adjustable), 1 Mhz

KVAL P/N: **BEC-ES5101**



Power supply terminal for E-bus. Used to refresh or isolate the power bus.

KVAL P/N: **BEC-ES9410**



EK1100 EtherCAT Coupler Connection of Ethernet Terminal with EtherCAT networks

KVAL P/N: **BEC-EK1100**



EK1110 EtherCAT Extension

KVAL P/N: **BEC-EK1110**



2-port EtherCAT Junction

KVAL P/N: **BEK-EK1122**



Power Supply unit for CX2020, CX2030, and CX2040

KVAL P/N: **BEC-CX2100-004**



USB 2.0 Extender Tx

KVAL P/N: **BEC-CU8801-0000**

Motors- Baldor



Motor, 3/4 HP, 1750 RPM, 90 Volt DC TEFC 56C, Permanent Magnet SCR Drive (Commander, Feed)

KVAL P/N: **BACDP3440**



Motor, 3-HP, 3450 RPM, 145T Frame, 208/230-460V, 60 Hz (979, DL-2)

Substitute for: **BAL35A001T886H2**

KVAL P/N: **BAL35TT638Q060G1**



Motor 1/4 HP 3450 RPM 90 Volt DC Permanent Magnet Rigid Base. CAT#AP7402, Frame 74-AHP-O (Face)- (Modified Base).

KVAL P/N: **BALAP7402M**



Motor 1/3 HP 1725 RPM TEFC 56C 208-230/460 (Width Adjust) (Architech) (990-F2) (990-F3)

KVAL P/N: **BALCM3534**



Motor, Inverter Duty, 3/4 HP, 17525 RPM, 56C, 3 Phase 460/230V (Handler)

KVAL P/N: **BALIDNM3542**



Motor, 1-1/2 HP, 1725 RPM, 145T TEFC, 208-230/460 Volts (6 Shooter) (747)

Substitute for: **BALM3554T**

KVAL P/N: **BALEM3554T**



Motor, 3-HP, 3450 RPM, Machined with Taper 145T Frame, 208/230-460V, 60 HZ, 35R202T123

Substitute for: **BALM35R202T123**

KVAL P/N: **BAL35R202Q060G1**



Motor, 5-HP, 3450 RPM, Machined with Taper 184T Frame With Seal 400281, 208/230-440V, 60 HZ

Substitute for: **BALM36K887X100S**

KVAL P/N: **BAL36K887S042GIS**



Motor, 5 HP, 3450 RPM, 1-1/8 Shaft, 213 TEFC, 208-220/440 Volts, 60 Hz (555)

Substitute for: **BALM3706**
KVAL P/N: **BALEM3706**



Motor, 1/2 HP, 1140 RPM, TEFC 56C, 208-220/440 Volts (777)

KVAL P/N: **BALVM3539**



Motor 3/4 HP 1140 RPM TEFC 56C 208-220/440 Volt (Auto Feed)

KVAL P/N: **BALVM3543**



Motor 1 HP 1725 RPM TEFC 56C 208-230/460 (888)

Substitute for: **BALVM3546**

KVAL P/N: **BALVEM3546**



Motor, 3 HP, 3450 RPM, TEFC 145TC, 208-230/480 Volts (555)

KVAL P/N: **BALVM3559T**

To see our full line of products,

go to kvalinc.com and type

Bosh, Colombo

Find

Colombo Motors & Sensors



Spindle Motor, Colombo, 1.5 HP, RV55/1 FP1 CPE 20 DX, 230 Volts, 18,000 RPM, 300 Hz, 2 Pole

KVAL P/N: COLS55E389-1.5,2



Spindle Motor, Colombo, 3 HP, RV73/1 FP1 CPE 25 DX, 230/460 Volts, 8.6/5A, 18,000 RPM, 300 Hz, 2 Pole

KVAL P/N: COLS73E478-3D



Spindle Motor, Colombo, 7.5 HP, RV 90/2 FP1 SB CPE 25 DX, 220/380 Volts, 21.6/12.5 Amps, 18,000 RPM, 300/400

KVAL P/N: COLS90E810-7.5,D



12 HP, RV 135/22 50 FP1 SB CPE 40 DX Electronic Spindle 220/380 Volt 36.5/21 Amp, 18,000 RPM 300 Hz 2 Pole DWG135501

KVAL P/N: COLS135501-12D



Spindle Motor, Colombo, 11 HP, 220/380 Volt, 12000/24000RPM, RA/RC, 110/22 50 FB3 HSK-63-F CR PDE SL, 200/400 Hz

KVAL P/N: COLS63F0020-11D



Sensor S3 for the Colombo Spindle motor (COLS63F0020-11D), Type SI8-CI PNP NO Conn Length 50mm (Tool Changer Sensor)

KVAL P/N: COLS3



Sensors S2 S4 for the Colombo Spindle motor (COLS63F0020-11D), 5mm cable

KVAL P/N: COL5MM



Sensor S1 for the Colombo Spindle motor (COLS63F0020-11D) 8mm

KVAL P/N: COL8MM

Dewalt



Heavy-Duty 1/2" (13mm) Joist & Stud Drill, DEW124, Modified Right Angle for DL-2 Edge Prep.

Can Only Sell This Part Modified

KVAL P/N: DEW124M



Collet 1/2" For DEWALT 610, 150061

KVAL P/N: DEW610-08



Router, Dewalt 616, 1-3/4 HP, Complete with Base, 1/4 & 1/2 Collet Capacity, 24,500 No-Load RPM

KVAL P/N: DEW616



Router, Dewalt, Model 616, 1-3/4 HP Fixed Base Route

KVAL P/N: DEW616B

Ekstrom-Carlson



Saw Arbor Motor, Left Thread, Ekstrom-Carlson, 3.6HP, 3600 RPM, 230V-460V, 3 Phase, 60 Hz, 1" Shaft Dia, Standard Length (Right Head-Movable Side used on 979-2, use with 36MM Open End Wrench)

KVAL P/N: H71C2SE LHT



Saw Arbor Motor, Right Thread, Ekstrom-Carlson, 3.6HP, 3600 RPM, 230V-460V, 3 Phase, 60 Hz, 1" Shaft Dia, Standard Length (Left Head-Fixed Side used on 979-2, use with 36MM Open End Wrench)

KVAL P/N: H71C2SE RHT

Dayton



Gearmotor, Right Angle, 115V, 50/60 Hz, 1-15HP, 4.5 RPM, 250 In/Lb Torque, 1/2" Dia Output Shaft, Base Mount, Sleeve Bearings

Substitute for: DAY1LRA7

KVAL P/N: BISON022Q607-1787R



Servo Amplifiers



MM23001C DC Drive Vari Speed Control 110V or 220V, SCR Adjustable Speed Drives for DC Brush Motors

KVAL P/N: MM23001C



Servo Amplifier, Lenze, 12 Amp, Digital Servo 941, Position Servo AC Tech

KVAL P/N: E94R120Y2NRM



Servo Amplifier, Lenze, Breakout Module, E94ZATB02

KVAL P/N: E94ZATB02



Drive, FR-E720-080-SCNA Mitsubishi FR-E700 Series Variable Frequency Drive, 240VAC 3Ph In/Out, 1.5KW
Substitute for: FRE720080NA

KVAL P/N: FRE72008SC-NA



Drive, FR-E720-110-SCNA Mitsubishi FR-E700 Series Variable Frequency Drive, 240VAC 3Ph In/Out, 2.2KW
Substitute for: FRE72011NA

KVAL P/N: FRE72011SCNA



Drive, FR-E720-330-SCNA Mitsubishi FR-E700 Series Variable Frequency Drive, 240VAC 3Ph In/Out, 7.5KW
Substitute for: FRE720330NA

KVAL P/N: FRE720330SCNA



Drive, FR-E740-170-SCNA Mitsubishi FR-E700 Series Variable Frequency Drive, 480VAC 3Ph In/Out, 10 HP 17 Amps Out
Substitute for: FRE74017NA

KVAL P/N: FRE740170SCNA



Drive, FR-E740-300-SCNA Mitsubishi FR-E700 Series Variable Frequency Drive, 480VAC 3Ph In/Out, 20 HP 30 Amps Out
Substitute for: FRE740300NA

KVAL P/N: FRE740300SCNA

Parker Servo Motors



Servo Motor, 3", 2400 rpm, 27.5 in/lbs, 3.7 amps or MPM892BSG7G1N

KVAL P/N: MPM892BTG7G1N



Servo Motor AC 45 in/lbs, Continuous Torque, 3000 rpm (4200 rpm Max.)

KVAL P/N: MPM1141ATG7G1N



Servo Motor, AC, 50 in/lbs, Continuous Torque, 1500 rpm, (2100 rpm Max.)

KVAL P/N: MPM1141BTG7G1N



Servo Motor, AC, 69 in/lbs, Continuous Torque, 3000 rpm, (4200 RPM MAX)

KVAL P/N: MPM1142ATG7G1N



Servo Motor, AC, 115 in/lbs, Continuous Torque, 2400 rpm, (2700 rpm Max.)

KVAL P/N: MPM1421ATG7G1N



Motors - Perske



Rear Fan Cover with Electrical Fitting Hole, Perske 1 & 2 HP Motor

KVAL P/N: 804C



Saw Arbor Motor, Left Hand, Perske, KCS70-12-2LH, 4HP, 36,000 RPM, 230/460 Volts, 60HZ, 1-1/8 Arbor

KVAL P/N: PERKCS70122LH



Saw Arbor Motor, Right Hand, Perske, KCS70-12-2RH, 4HP, 36,000 RPM, 230/460 Volts, 60HZ, 1-1/8 Arbor

KVAL P/N: PERKCS70122RH



Router, Perske, .37HP, 24000RPM, 400HZ, 220 VOLT

KVAL P/N: PERKNS21-05-2400



Router, Perske, KNS22-08-2, .5 KW, 18,000 - 24,000 RPM, 300/400 Hz

KVAL P/N: PERKNS22082



Router Perske, 1 HP, 18,000 RPM, 220/380 Volts 300 HZ, 1/2 Collet Capacity.

KVAL P/N: PERKRS35.1-2D



Router Perske, 2HP, 230/380V 300 - 400Hz, 18000-24000 RPM, 1/2 Collet Capacity

KVAL P/N: PERKRS35.5-2D



Router, Perske, VS50.09-2, 3 HP, 21,000 RPM, 220V, 360 Hz

KVAL P/N: PERVS503



Router, Perske, High Frequency, 7 HP (Convert From 5.5 H.P.) 300HZ 220/380V, 18000 RPM

KVAL P/N: PERKRVS51.14-2D

Leeson



Motor, Leeson, 1 HP, 1725 RPM, Three Phase 56C Frame Footless 208-230 /460V (Handler Carriage)
Substitute for: LEE110048

KVAL P/N: LEE114638

Porter Cable



Collet, 1/2" Collet & Nut Combination For Porter Cable Router 7519

KVAL P/N: **POR42950**



Porter Cable, Router, Model 690 LR, 11 Amps, 1-3/4 HP

KVAL P/N: **POR690LR**



Porter Cable, Router, Model 7519, 3-1/4 HP with Standard base, Soft Start 15 Amps AC only, 1/2" Collet, 21,000

KVAL P/N: **POR7519**



Porter Cable Router, Model 7519, 3-1/4 HP. No Soft Start, With Mod. Base & Adapter Plate. 15 Amps 120V AC, 1/2" Collet, Replaces Dewalt 628 & Bosh 1615

KVAL P/N: **POR7519M1**



Wing Nut For Porter Cable Router Bases, Used on 7519 Model

KVAL P/N: **POR874582**



Wrench, 1-1/8" Wrench, Porter Cable 7519 and 690 LR, #208

KVAL P/N: **POR7519WR**



Base Clamp Screw, 842580, For non threaded Porter Cable Router

KVAL P/N: **POR842580**

Bosch Router



Router, Bosch, with Non Modified Base, 2 H.P., 120 VAC, 11 AMP, 25,000 RPM, 1/2 Collet

KVAL P/N: **BOS1617**



Router, Bosch, Motor Only, 2 HP, 120 VAC, 11 amp, 25,000 RPM, 1/2 Collet

KVAL P/N: **BOS16171**



Router, Bosch 1617, Base Only, 3-7/8" Hole Centers

KVAL P/N: **BOS1617MB1**



Bosch 1617 Router Mounted on Base & (4) KVALBB12A Bearings With Seals. Back Section Bolt Plate Router Assembly. (Face Plate Router)

KVAL P/N: **15-00-UPK11**



Bosch, 1/2" Collet with Nut, 1604A Router, 2-610-906-284

KVAL P/N: **BOS36070**



Brushes



Brush for Baldor Motor CDP3335,
BP5011P01SP

KVAL P/N: **BACDP3335BR**



Brush, Carbon Grade SA-35
Brushes for Baldor Motor
CDP3440

KVAL P/N: **BAL3440BR**



Brush, For Baldor DC Motor,
CDP3330

KVAL P/N: **BALBP5011T01**



Brush Package, Pair, For 3265
Laminate Trimmer

KVAL P/N: **BLA3265BR**



Brush Package for 3310 Router
400814-00 Brushes 3315 Motor
and DEW610

KVAL P/N: **BLA3310BA**



Brush Package Pair - 3328 Router
Motor

KVAL P/N: **BLA3328BR**

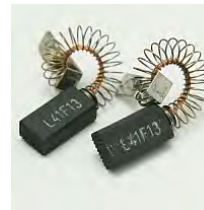

Brush Package, Pair, for 3337
ELU Router

KVAL P/N: **BLA3337BR**



Brush, For Bosch 1615 Router,
1607014103

KVAL P/N: **BOS1615BR**



Brush, Bosch 1617 Router, 3604321514

KVAL P/N: **BOS1617BR**



Brush Package Pair - 22797 Dayton
Gearmotor

KVAL P/N: **DAY1R410**



Brush Package Pair - 2M169B Dayton
DC Motor

KVAL P/N: **DAY2M169B**



Brush For 1/2" Drill Right Angle Heavy
Duty, 158459-00

KVAL P/N: **DEW124BR**



Brush For 1/2" Drill Right Angle Heavy
Duty, 617848-05

KVAL P/N: **DEW124BR-1**



Brush For Dewalt 610 Router, 400814

KVAL P/N: **DEW400814**



Brushes for the Dewalt 616 Router Motor.

KVAL P/N: **DEW616BR**



Brush Set for Laminate Trimmer

KVAL P/N: **DEW670BR**

To see our full line of products,

go to kvalinc.com and type

brushes

Find

Brush for Porter Cable 690LR,
869659KVAL P/N: **POR690BR**Brush, Porter Cable 7310, Laminate
Trimmer, 690741KVAL P/N: **POR7310BR**Brush, Porter Cable 7519 Rout-
er, 698873KVAL P/N: **POR7519BR**Brush for Porter Cable 513, Lock Mortis-
er, 513T6 Power unit.KVAL P/N: **POR513BA**

Brushes For Hitachi TR12 RTR

KVAL P/N: **HITATR12BR**

Control Transformers

Transformer, 100VA, Primary Volt:
208/230/460V, Secondary: 120V, MI-KVAL P/N: **B100MBT13XK**Transformer, 250VA, Primary Volt:
208/230/460V, Secondary: 115VKVAL P/N: **B250MBT13XKF**Transformer, 350VA, Primary Volt:
208/230/460V, Secondary: 115VKVAL P/N: **B350MB13XKF**

To see our full line of products,

go to kvalinc.com and type

Photo Eyes

Find

Diffuse Photo Eyes



Diffuse Photo Eye Banner S182VNSQ8
24 Volts DC 100MM Range M12 Quick
Connect 18MM Dia (CP18D1DNLC) or
Equal. S18SN6DQ-19161
Substitute for: PHOTO-M12-BANNER
KVAL P/N: BANS182VNSQ8



S182VNFF50Q8 24 Volts DC 2"
Fixed Field 18MM Dia. NPN
(Banner) (use M12 4Pin Cord)
Substitute for DIFUSEFF2-M12
KVAL P/N: BANS182VNFF50Q8



S182VNFF100Q8 Diffuse Photo Eye 24
Volts DC 3.9" Fixed Field 18MM Dia.
NPN (Banner) (Uses M12 4 Pin Cord Not
Included)
Substitute for: DIFUSEFF4-M12-BLK
KVAL P/N: BANS182VNFF100Q8



Banner S182NAELQ8 18MM Tubular
Thru Beam Emitter 24 V DC With M12
Quick Connect. (Use With Receiver
S182VNRLQ8)
KVAL P/N: BANS182NAELQ8



Banner S182VNRLQ8 18MM Tubular
Thru Beam Receiver 24 V DC With M12
Quick Connect. (Use With Emitter
S182NAELQ8)
KVAL P/N: BANS182VNRLQ8



Lens, For Sensor SM312CV, Ban-
ner, UC300C.7
KVAL P/N: CVLENS



Lens, For Sensor SM312D, Banner,
UC300L
KVAL P/N: DLENS



Diffuse Reflection Sensor NPN, Sensing
Range 2-200MM, M12 Connector.(700-C)
Substitute for: QH23SN6DLQ5
KVAL P/N: IFM-O6H205



Diffuse Photo Eye 24 Volts DC
4" (100MM) With Background Suppres-
sion Right Angle 18MM Dia. IFM Effector
(Uses M12 4 Pin Cord Not Included)
OGH282

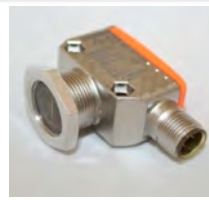

Diffuse Photo Eye 24 Volts DC
8" (200MM) With Background Suppres-
sion Right Angle 18MM Dia. IFM Effector
(Uses M12 4 Pin Cord Not Included)
KVAL P/N: OGH283



Diffuse Photo Eye 24 Volts DC 2" Fixed
Field Right Angle 18MM Dia (Banner)
(Uses M12 4 Pin Cord Not Included)
KVAL P/N: QS18VN6FF50Q8-M12



Diffuse Photo Eye 24 Volts DC 4" Fixed
Field Right Angle 18MM Dia (Banner)
(Uses M12 4 Pin Cord Not Included)
KVAL P/N: QS18VN6FF100Q8M12



SM312CVQDP Convergent Photo
Beam 10-30 Volts DC. With 6"
Quick Disconnect M12 Pigtail
Substitute for: SM312CV
KVAL P/N: SM312CVQDP



SM312DQDP Diffuse Photo Beam,
10-30 Volts DC, Mini Beam Sensor.
With 6" Quick Disconnect M12
Pigtail. **Substitute for: SM312D**
KVAL P/N: SM312DQDP



BANNER PORTABLE DEMO BOX
SENSOR TESTER
KVAL P/N: DBQ5



Proximity Switches & Cables

Sensor, Cord M12 Conn 4 Wire DC
10 Meters

KVAL P/N: M12-4PIN-DC-10M

Sensor, Cord M12 Connector 4 Wire
DC, 10 Meters cable, 90 Deg Fitting

KVAL P/N: M12-4PIN-DC-10M-RA

Sensor, Cord M12 Conn 4 Wire DC
5 Meters

KVAL P/N: M12-4PIN-DC-5M

Sensor, Cord M12 Connector 4 Wire
DC, 5 Meter cable, 90 Deg Fitting

KVAL P/N: M12-4PIN-DC-5M-RA

Electrical, Cord M8, Connector 3 Wire
DC 5 Meters, TURCK PKG 3-5/S90

KVAL P/N: M8-3PIN-DC-5M

Electrical, Cord M8, Connector 3 Wire
DC 10 Meters

KVAL P/N: M8-3PIN-DC-10M

Sensor, Proximity Sensor Inductive,
12mm Dia., Shielded, Sensing Range
2mm

KVAL P/N: PROX12DC-M12-4PIN

Sensor, Proximity Sensor
Inductive, 12mm Dia., Shielded,
Extended Range

KVAL P/N: PROX12DC-M12-4PIN-XR

12mm Dia Shielded Prox M12 Conn
Inductive Turckbi 4-M12E-AN6X-H1141
62mm Overall Length 46mm Threaded
Length Sensor. 24VDC

KVAL P/N: PROX12-4MM-M12-62OAL

TURCK BI2-G12K-AN6X-7M Inductive
Proximity Switch 12MM Dia.. 24 VDC
(30MM LENGTH)
Substitute for: SHORT12DC

KVAL P/N: SHORT12DC-M12-QDP

Sensor, 18mm Dia. Shielded Prox M12,
Conn Turck BI5-M18-AN6X-H1141,
36mm Threaded Barrel 51mm OAL.

KVAL P/N: PROX18DC-M12-SHORT

Sensor, 18mm Dia. Shielded Prox M12,
Conn Turck BI5-M18E-AN6X-H1141,
56mm Threaded Barrel 71mm OAL.

KVAL P/N: PROX18DC-M12-4PIN

Sensor, Inductive Proximity Switch,
18MM DIA SHEILDDED PROX M12
CONN IFM IGS202, Extended Range.

KVAL P/N: PROX18DC-M12-4PIN-XR

Electrical, Proximity Switch,
Unshielded, 30MM Dia, 24 Volts
DC, M12 Connector (Handler)

KVAL P/N: PROX30DC-M12-4PIN

To see our full line of products,

go to kvalinc.com and type

Mounting Brack-

Find

Mounting Bracket



Photo Eye Bracket, 18mm, Horizontal Adjustment, Stainless Steel, Flat, For

KVAL P/N: **KVA18MMBRK-A1**



Photo Eye Bracket, 18mm, Horizontal Adjustment, Stainless Steel, Formed, For Single Eye

KVAL P/N: **KVA18MMBRK-A2**



Proximity Sensor Inductive, 12mm Dia., 24 DC, 7 meters cable, E11202NPOSL-7M or E11202NPOSL-XM Carlo Gavazzi

KVAL P/N: **KVA18MMBRK-B1**



Photo Eye Bracket, 18mm, Horizontal Adjustment, Stainless Steel, Formed For Width Adjust

KVAL P/N: **KVA18MMBRK-B2**

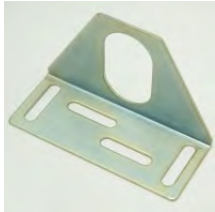

Mounting Bracket, MB30, Turck

KVAL P/N: **MB30**



Mounting Block, MBS12, Turck

KVAL P/N: **MBS12**



12mm Metal Nut for 12mm Proximity Sensor

KVAL P/N: **NUT-12MMM**



18mm Metal Nut for E3 Diffuse Photo Eye

KVAL P/N: **NUT-18MMM**



18mm Plastic Nut for E3 Diffuse Photo Eye

KVAL P/N: **NUT-18MMMP**



Bracket, 18mm Sensor, BANNER

KVAL P/N: **SMB312PD**

Drum Switch



Reversing Drum Switch, Square D, 2 HP, Maintained or Momentary Operation, 2601AG2

KVAL P/N: **AG2**



Thru Beams



Balluff Fork Sensor, 20mm, NPN (M8 3 Pin Cord Not Included) (700-C) **Substitute for: GLS20RBN**
KVAL P/N: **BGL000T**



Banner Slot Sensor With M12 Connector 5 Wire Photo beam 10-30 Volts DC (Handler & ON-3)
KVAL P/N: **SL30VB6VQ**



Sensor, DC Thru-Beam, Miniature, 1 Emitter & 1 Receiver (700-C PRE 2009) & (Handler PRE 2006)
KVAL P/N: **SUNXEX13EB-R**



Sensor, Mounting Bracket L-Shaped For SUNX EX11EB
KVAL P/N: **SUNX-MS-EX10-3**



Banner 18MM DIA Tubular Thru Beam Emitter 24VDC With M12 Quick Connect
Substitute for: THRUEMIT3
KVAL P/N: **S186EQ-M12**



Banner 18MM Tubular Thru Beam Receiver 24VDC With M12 Quick Connect
Substitute for: THURREC3
KVAL P/N: **S18SN6RQ-M12**



Banner Thru Beam Emitter 24 Volts DC Right Angle 18MM M12 Connector
Substitute for: T186E-W/30
KVAL P/N: **T186EQ**



Banner Thru Beam Receiver 24 Volts DC NPN Light Or Dark Operate Right Angle 18MM M12 Connector.
Substitute for: T18SN6R-W/30
KVAL P/N: **T18SNRQ**

Position Sensing Switches



Bimba Hall Effect Sensor with Quick Disconnect.
KVAL P/N: **BIMHSKQ**



Inductive Cylinder Position Sensor, Turck, W/KLP80 Hall Effect Sensor with Quick Disconnect
KVAL P/N: **BIM-PST-AN6XV1131**

To see our full line of products,

go to kvalinc.com and type

Limit Switch

Find

Limit Switch



Micro Mini Pre-Wired Rotary Enclosed Switch 914CE16-9 or OMRON D4C-1620

KVAL P/N: 914CE169



Micro Switch Limit Switch Pin Plunger with 9' Cord (700-C) or ERSCE E600-0-AM (6FT Cord) or OMRON D4C-1601.

KVAL P/N: 914CE19



Limit Switch, Micro, Replacement Head

KVAL P/N: 9PA16



Safety Switch Hinge Pin, 1NO & 1NC Carlo Gavazzi

KVAL P/N: PS21HNT11HZTOO



Limit Switch, ERSCE, E102-00-AM, Miniature Pin Plunger

KVAL P/N: E10200AM



Key Operated Interlock Switch Straight Key.

KVAL P/N: GKBA1L6



IDEC Key Limit Switch (Does Not Include Key), IEC60947-5-1

KVAL P/N: HS5B-11B



IDEC Key For HS5B-11B Limit Switch, Part# HS9Z-A51, Straight Key (Does Not Include Switch)

KVAL P/N: HS5B-11B-KEY-A51



IDEC Key For HS5B-11B Limit Switch, Part# HS9Z-A51, L-Shaped

KVAL P/N: HS5B-11B-KEY-A52



Limit Switch, Micro Switch, Standard Limit Switch (1LS312-L)

KVAL P/N: LIMITSWAA



Limit Switch Low Pre-Travel, Micro Switch (1LS319-L)

KVAL P/N: LIMITSWBB

Push Button Station



Push Button Station, Square D, Nema, 1 Start/Stop

KVAL P/N: BG201



Push Button Station, Square D, Nema, 1 Open/Close

KVAL P/N: BG207



Limit Switch Arm



Standard Limit Switch Arm 1-1/2 Radius 3/4 Wheel
KVAL P/N: 6PA121



Limit Switch Arm, Large Wheel Standard 1-1/2" Radius With 1-1/2 Wheel, Allen Bradley
KVAL P/N: 802TWIG



Limit Switch Arm, Nylon Rod Adjustable Up to 5" Radius, E50KL399, Cutler Hammer
KVAL P/N: E50KL399



Limit Switch Arm Large Wheel Long, 2-1/2" Radius With 1-1/2" Wheel,
KVAL P/N: LSZ65FF



Limit Switch Arm Standard Roller Lever, 1-1/2" Radius With 1
KVAL P/N: LSZ51J



Limit Switch Arm Roller Lever 1-1/2 Radius with 3/4 Wheel 1-1/4 Wide
KVAL P/N: LSZ51M



Limit Switch Arm Adjustable Radius Up to 3-1/2 Radius 3/4" Wheel 1- Wide
KVAL P/N: LSZ52E



Limit Switch Arm Adjustable Radius Up to 3-1/2 Radius 1-1/2" Wheel 1/4 Wide
KVAL P/N: LSZ52K



Limit Switch Arm, Aluminum Rod, 5-1/2 Radius
KVAL P/N: LSZ54M



Limit Switch Arm Outside Offset 1-1/2 Radius with 3/4 Wheel 1/4 Wide
KVAL P/N: LSZ55B



Limit Switch Arm Outside Offset 1-1/2 Radius with 3/4 Wheel 1/4 Wide
KVAL P/N: LSZ55D



Limit Switch Arm, 2.5 Inch Radius, Arm Wheel is Nylon and 1.5 Dia. .25 Width.
KVAL P/N: LSZ65FF



Limit Switch Arm, Adjustable up to 3-1/2 Radius 11/16 Wheel OM-
KVAL P/N: OMRARM



Limit Switch Arm, Wide Wheel, 2" Radius with 11/16 DIA X 11/16 Wheel
KVAL P/N: WL1A200



To see our full line of products,

go to kvalinc.com and type

pushbutton

Find

**Illuminated**

Pushbutton Operator, Illuminated, Momentary, Type: K, Size: 30mm, Clear Plastic Top, With No Light Module

KVAL P/N: **K1L**

Pushbutton Operator, Illuminated, Momentary, Type: K, Size: 30mm, Clear Plastic Top, Amber Lens, 120V, Without Contact Block

KVAL P/N: **K1L1A**

Pushbutton Operator, Illuminated, Momentary, Type: K, Size: 30mm, No Light Module

KVAL P/N: **K2L**

Pilot Light, No Light Module or Lens, Standard, Type: K, Size: 30mm, 9001KP

KVAL P/N: **KP**

Illuminated Pushbutton Operator Push (Maintained) - Pull (Maintained), Square D

KVAL P/N: **KR9P1**

Pushbutton Illuminated, Maintained (Push/Pull), 2 Position, Green Button, 1 N.C. Contact, Type: K, Size: 30mm, 10A, Square D

KVAL P/N: **KR9P1GH14**

Pushbutton Illuminated, Maintained (Push/Pull), 2 Position, Green Button, 2 N.C. Contact, Type: K, Size: 30mm, 10A, Square D

KVAL P/N: **KR9P1GH8**

Pushbutton Illuminated, Maintained (Push/Pull), 2 Position, Red Button, 2 N.C. Contact, Type: K, Size: 30mm, 10A, Square D, 9001KR9P1RH8

KVAL P/N: **KR9P1RH8****Non-Illuminated**

Selector Cam Switch, 8 Position, 30 Deg, 30MM, BCD Out (0-7) Overlapping Contact IDEC ACSNO-003-8POS-TABLE-Y-B

KVAL P/N: **BCD-0-730MM30**

Pushbutton Operator Momentary, Non-Illuminated, Type: K, Size: 30mm

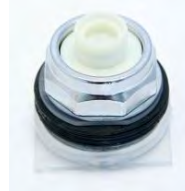
KVAL P/N: **KR1U**

Pushbutton Operator, Non-Illuminated, Mushroom, Momentary, Type: K, Size: 30mm, Square D

KVAL P/N: **KR20**

Pushbutton Operator, Non-Illuminated, Idec Operator. Use with Contacts HW-U10 (NO) & HW-U01 (NC)

KVAL P/N: **ABD3400T8**

Pushbutton Non-Illuminated, Momentary, Black, with 1 N.O. Contact, Type: K, Size: 30mm, 10A, 600V

KVAL P/N: **KR24BH36**

Pushbutton Non-Illuminated, Momentary, Green Button, 1 N.O Contact, Type: K, Size: 30mm, 10A, 600V, Square D

KVAL P/N: **KR24GH36**

Pushbutton Non-Illuminated, Momentary, Red Button, 1 N.C. Contact, Type: K, Size: 30mm, 10A, 600V, Square D

KVAL P/N: **KR24RH6**

Non-Illuminated Pushbutton Operator Push - Momentary; Pull - Maintained, Square D

KVAL P/N: **KR9**



Dual Pushbutton



Non-Illuminated Pushbutton Operator Momentary-Momentary, Type: KX, Square D

KVAL P/N: **KXRC**



Dual Pushbutton Non-Illuminated, (2) Momentary, Start/Stop, 1 N.O. & 1 N.C. Contact, Type: KX, Size: 30mm, 10A

KVAL P/N: **KXRC136**



Non-Illuminated Pushbutton Operator Momentary-Momentary (with Interlock), Square D

KVAL P/N: **KXRD**



Dual Pushbutton Non-Illuminated, (2) Momentary (with interlock), Blue-Blue Button, 2 N.O. Contact, Type: KX, Square D, OPEN—CLOSE

KVAL P/N: **KXRDLLH7-OC**



Dual Pushbutton Non-Illuminated, (2) Momentary (with interlock), Blue-Blue Button, 2 N.O. Contact, Type: KX, Square D, FORWARD—REVERSE

KVAL P/N: **KXRDLLH7-FR**

Contacts



Pushbutton Contact Square D 1-NO 1-NC Clear. Use with Square D Operators

KVAL P/N: **KA1**



Pushbutton Contact Square D 1-NO Green. Use with Square D Operators

KVAL P/N: **KA2**



Pushbutton Contact Square D 1-NC Red. Use with Square D Operators

KVAL P/N: **KA3**



IDEC Contacts 1-NO GREEN for ABD3400T8

KVAL P/N: **HW-U10**



IDEC Contacts 1-NC RED for ABD3400T8

KVAL P/N: **HW-U01**

To see our full line of products,

go to kvalinc.com and type

Mushroom lens

Find

Mushroom Push/Pull Lens



Push/Pull Knob, Green, Square D, for KR8, KR9, SKR8, SKR9 Operators

KVAL P/N: G22



Push Pull Knob, Blue, For KR8, KR9 SKR8, SKR9 Operators, Square D, 9001L22

KVAL P/N: L22



Push Pull Knob, Red, For KR8, KR9 SKR8, SKR9 Operators, Square D, 9001R22

KVAL P/N: R22



Push Pull Knob Red Push Emergency Stop

KVAL P/N: R2205



Push/Pull Knob, White, Square D, for KR8, KR9, SKR8, SKR9 Operators

KVAL P/N: W22



Push/Pull Knob, Yellow, Square D, for KR8, KR9, SKR8, SKR9 Operators

KVAL P/N: Y22

Mushroom Pushbuttons



Mushroom Knob, Black, Square D, 1-3/8 in. Screw-on for KR24 and SKR24

KVAL P/N: K92B



Mushroom Knob, Green, Square D, 1-3/8 in. Screw-on for KR24 and SKR24

KVAL P/N: K92G



Mushroom Knob, Blue, Square D, 1-3/8 in. Screw-on for KR24 and SKR24

KVAL P/N: K92L



Mushroom Button, Red, Square D, 1-3/8 in. Screw-on for KR24

KVAL P/N: K92R



Mushroom Knob, Orange, Square D, 1-3/8 in. Screw-on for KR24 and SKR24

KVAL P/N: K92S



Mushroom Knob, Yellow, Square D, 1-3/8 in. Screw-on for KR24 and SKR24

KVAL P/N: K92Y



Mushroom Button, E-Stop, Red, Square D, 2-1/4 in. Screw-on for KR25 and SKR25

KVAL P/N: K93R



Mushroom Button, Orange, Square D, 2-1/4 in. Screw-on for KR20

KVAL P/N: K93S



Pilot Light Lens



Lens, Amber, For Pilot Light, 30mm

KVAL P/N: A31



Lens, Green, For Pilot Light, 30mm

KVAL P/N: G31



Lens, Red, For Pilot Light, 30mm

KVAL P/N: R31



Lens, White, For Pilot Light, 30mm

KVAL P/N: W31



Lens, Yellow, For Pilot Light, 30mm

KVAL P/N: Y31

Pushbutton Button Cover



Pushbutton Button Cover, White, Type: KX, Size: 30mm

KVAL P/N: KXAW2



Pushbutton Button Cover, Amber, Type: KX, Size: 30mm

KVAL P/N: KXAA2



Pushbutton Button Cover, Green, Type: KX, Size: 30mm

KVAL P/N: KXAG2



Pushbutton Button Cover, Blue, Type: KX, Size: 30mm

KVAL P/N: KXAL2



Pushbutton Button Cover, Red, Type: KX, Size: 30mm

KVAL P/N: KXAR2

Potentiometer



Potentiometer, Operator with Knob, 10k Ohms, Square D (Uses Knob CSH-YB)

KVAL P/N: K2108



Gloved Hand Selector

Selector Switch Lever, Amber,
Square D

KVAL P/N: A24

Selector Switch Lever, Black,
Square D

KVAL P/N: B25

Selector Switch Lever, Green,
Square D

KVAL P/N: G24

Selector Switch Lever, Blue,
Square D

KVAL P/N: L24



Selector Switch Lever, Red, Square D

KVAL P/N: R24

Selector Switch Lever, Orange,
Square D

KVAL P/N: S25



Selector Switch Lever, White, Square D

KVAL P/N: W24



Selector Switch Lever, Yellow, Square D

KVAL P/N: Y24

Mushroom Illuminated Push/Pull Lens

Mushroom Button, Amber, For Illumi-
nated Push Button

KVAL P/N: A20

Mushroom Button, Green, For Illumi-
nated Push Button

KVAL P/N: G20

Mushroom Button, Blue, For Illuminated
Push Button

KVAL P/N: L20

Mushroom Button, Red, For Illuminated
Push Button

KVAL P/N: R20

Mushroom Button, White, For Illuminat-
ed Push Button

KVAL P/N: W20

Mushroom Button, Yellow, For Illumi-
nated Push Button

KVAL P/N: Y20



Selector Switch



Selector Switch, Illuminated, 2 Position, Green Gloved Hand Knob, Type: K, Size: 30mm, With 1 NC Contact

KVAL P/N: **K12J1FGH14**



Selector Switch Operator Maintained, 2 Position, Non-Illuminated, Type: K, Size: 30mm, Square D

KVAL P/N: **KS12**



Selector Switch, Non-Illuminated, 2 Position, Amber Gloved Hand Knob, Type: K, Size: 30mm, Square D

KVAL P/N: **KS12FAH14**



Selector Switch Non-Illuminated, Maintained, 2 Position, Black Knob, Type: K, Size: 30mm, 10A

KVAL P/N: **KS12FBH14**



Selector Switch, Non-Illuminated, 2 Position, Green Gloved Hand Knob, Type: K, Size: 30mm, Square D

KVAL P/N: **KS12FGH14**



Selector Switch, Non-Illuminated, 2 Position, Blue Gloved Hand Knob, Type: K, Size: 30mm, Square D

KVAL P/N: **KS12FLH14**



Selector Switch, Non-Illuminated, 2 Position, Red Gloved Hand Knob, Type: K, Size: 30mm, Square D

KVAL P/N: **KS12FRH14**



Selector Switch, Non-Illuminated, 2 Position, White Gloved Hand Knob, Type: K, Size: 30mm, Square D

KVAL P/N: **KS12FWH14**



Selector Switch Operator Maintained, 3 Position, Non-Illuminated, Type: K, Size: 30mm, Square D

KVAL P/N: **KS42**



Selector Switch Operator, Non-Illuminated, Maintained, 2 Key Position, Type: K, Size: 30mm, Square D

KVAL P/N: **KS12K3**



Selector Switch Non-Illuminated, Maintained, 3 Position, Blue Knob, 2 N.O. Contact, Type: K, Size: 30mm, 10A

KVAL P/N: **KS42FLH7**



Selector Switch Non-Illuminated, Maintained, 3 Position, Orange Knob, 1 N.O. & 1 N.C. Contact, Type: K, Size: 30mm, 10A, Square D

KVAL P/N: **KS42FSH37**



Selector Switch Non-Illuminated, Maintained, 3 Position, White Knob, 2 N.O. Contact, Type: K, Size: 30mm, 10A

KVAL P/N: **KS42FWH7**



Selector Switch Operator Maintained, 4 Position, Non-Illuminated, Type: K, Size: 30mm, Square D

KVAL P/N: **KS88**



Selector Switch Operator Maintained, 4 Position, Non-Illuminated, Yellow, Gloved Hand Knob, Type: K, Size: 30mm, Square D

KVAL P/N: **KS88FYH62**

Keys



Selector Switch Operator Key, E-10, 29411-001100, Square D

KVAL P/N: **KEY29411-001100**

To see our full line of products,

go to kvalinc.com and type

Terminal Blocks

Find

Enclosures



Box, NEMA 4, 45mm X 50mm X 30mm RITTAL GA Series

KVAL P/N: BOX45MM50MM30MM

Surge Suppressor



Surge Suppressor, 140 Volt AC, BC-1449-ND

KVAL P/N: MOV140VOLT

Switches Parts Hardware



Ring Nut, For Selector Switches

KVAL P/N: SK-46

Power Block



Power Block, 120 VAC Input & output, LR41887

KVAL P/N: PBA



Power Block, 120 VAC Input, No Output, LR41887

KVAL P/N: PBA1



Power Block, 10-30 Volt DC, NPN Output

KVAL P/N: PBT

Terminal Blocks



End Plate For Grounding Terminal Block, Entrelec.

KVAL P/N: 01036221



Terminal Block, 6mm, 30A, Grey, Screw 30A/600V Max., Accepts 24-10 AWG Wire M4/6, Screw Terminal

KVAL P/N: 011511607



Grounding Terminal Block, Entrelec, Green/Yellow, 24-10AWG, 6mm Width Electrically Connected To Rail

KVAL P/N: 016580901



Terminal Block, Euro-Style, 1129D Series with Wire Guard, 12 Poles, 14-20 AWG, Niedax-Kleinhuus

KVAL P/N: 1129D/12



Terminal Block, Euro-Style, 1129D Series with Wire Guard, 3 Poles, 14-20

KVAL P/N: 1129D/3



Terminal Block, Euro-Style, 1129D Series with Wire Guard, 4 Poles, 14-20 AWG, Niedax-Kleinhuus

KVAL P/N: 1129D/4



Terminal Block, Euro-Style, 1129D Series with Wire Guard, 5 Poles, 14-20 AWG, Niedax-Kleinhuus

KVAL P/N: 1129D/5



Terminal Block, Euro-Style, 1129D Series with Wire Guard, 9 Poles, 14-20 AWG, Niedax-Kleinhuus

KVAL P/N: 1129D/9



Terminal End Section Entrelec

KVAL P/N: 11836816



Terminal Block, Euro-Style, 159D Series with Wire Guard, 3 Poles, 12-18 AWG, Niedax-Kleinhuis

KVAL P/N: 159D/3



Terminal Block, Euro-Style, 159D Series with Wire Guard, 4 Poles, 12-18 AWG, Niedax-Kleinhuis

KVAL P/N: 159D/4



Connector Terminal Block Plug, 3 Pole, 3.81mm Pitch, Phoenix

KVAL P/N: 1803581



Connector Terminal Block Plug, 4 Pole, 3.81mm Pitch, Phoenix

KVAL P/N: 1803594



Connector Terminal Block Plug, 6 Pole, 3.81mm Pitch, Phoenix

KVAL P/N: 1803617



Connector Terminal Block Plug, 8 Pole, 3.81mm Pitch, Phoenix

KVAL P/N: 1803633



Connector Terminal Block Inverted Plug, 3 Pole, 3.81mm Pitch, Phoenix

KVAL P/N: 1857896



Connector Terminal Block Inverted Plug, 4 Pole, 3.81mm Pitch, Phoenix

KVAL P/N: 1857906



Connector Terminal Block Inverted Plug, 6 Pole, 3.81mm Pitch, Phoenix

KVAL P/N: 1857922



Connector Terminal Block Inverted Plug, 8 Pole, 3.81mm Pitch, Phoenix

KVAL P/N: 1857948



Ferrule, 16 AWG, 7mm Long, Weidmuller, Bag of 1000

KVAL P/N: 37270

Wire Connectors



Copper Connector, L125, Type L - Copper Single Conductor One Hole Mount for Conductor Range 8 Sol.-1/0 Str.

KVAL P/N: BLKBRNL125



Copper Connector, L70, Type L - Copper Single Conductor One Hole Mount for Conductor Range 14 Sol.-4 Str.

KVAL P/N: BLKBRNL70



Foot Switch Components



Foot Switch Contact 632-S Line Master

KVAL P/N: 536Q



Foot Switch 632-S Single Linemaster.

KVAL P/N: 632S



Twin Foot Switch Linemaster 632-S

KVAL P/N: 632S-TWIN



522-F28 Single Foot Switch Guard Linemaster. With Extra Height for Steel Toe Boots

KVAL P/N: 522-F28



522-D28 Single Foot Switch Guard Linemaster. With Extra Height for Steel Toe Boots

KVAL P/N: 522-D28

Safety Light Screen

Requires Programing & Additional Parts for Install, Call with Serial Number & Electrical Print



SLSE30-450Q8

Banner EZS Emmitter 30MM OD X 450 MM

SLSE30-900Q8

Banner EZS Emmitter 30MM OD X 900 MM

SLSE30-1200Q8

Banner EZS Emmitter 30MM OD X 1200 MM



SLSR30-450Q8

Banner EZS Receiver 30MM OD X 450 MM

SLSR30-900Q8

Banner EZS Receiver 30MM OD X 900 MM

SLSR30-1200Q8

Banner EZS Receiver 30MM OD X 1200 MM



Adhesive



Super Weatherstrip Adhesive
Black 5 Oz.

KVAL P/N: DUN8008



Gorilla Glue, 2 OZ. Tube for KVAL
Tapes **Substitute for: DUCO-1.0**

KVAL P/N: GLUE FOR TAPES



Epoxy, DEVCON®, 5 Minute®
Epoxy in DevTube, 25ml

KVAL P/N: EPOXY-2.5

Corrosion Inhibitors



Heavy Duty Rust Inhibitor, Size16 oz., Net Weight 11 oz., Waxy Film
Stops Rust and Corrosion and Provides Protective Coating for up to 2
Years. Penetrates to Displace Moisture and Provides Anti Seize Coating

Standards MIL-C-16173D-Grade 2
MIL-C-0083933A
BMS 3-23G, Type II
Class I, Grade A and B
DMS 2150
Airbus TN A.007.10138 Type I, Grade 2

KVAL P/N: GRA6Y74

Grease, Silicon Spray



Silicone Spray 10 Oz Lubricant.

KVAL P/N: DAY2X988B



METAFLUX Lubrication Metal For
DL-NCB|DL-NCC Tool Changer,
ART.NR.70-8508 (4 gram)

KVAL P/N: LUBE-70-8508



Grease, Multifak® EP 2 NLGI, 14
oz. Cartridge, Chevron

KVAL P/N: LUBE-EP



Grease, Longtime PD-2, Castrol,
14oz, High Pressure grease for
long-term lubrication

KVAL P/N: LUBE-PD2



Lubricant,kit

- Includes:
- (1) Gallon of Systlube Hydraulic Oil
 - (2) Tube of Multi-FAK Grease EP-2 10 Oz
 - (1) Grease Gun
 - (1) Adaptor Needle Nozzle
 - (1) 8" Extension, 180 Deg Swivel For Grease Gun
 - (1) Silicon Spray 10 Oz

KVAL P/N: LUBEKIT



Grease, SIL-GLYDE, Lubricating
Compound, 8oz. (226g), For Handler Clutch

KVAL P/N: MC1286K11

To see our full line of products,

go to kvalinc.com and type

lubricant

Find

Lubricants



Hydraulic Oil, 1 Gal Container

KVAL P/N: SYSLUBG

Paint



Spray Paint, Aerosol Touch-Up
Acrylic Gloss KVAL Green

KVAL P/N: KVAL-SPRAYPAINT

Pipe Sealant



Loctite® 242, Medium Strength
Screw Thread Threadlocker, Size
10 ml, Color Red

KVAL P/N: LOC242



Loctite® QuickStix 561 PST, Pipe
Sealant With PTFE, 19g Tube

KVAL P/N: LOC37127



Vibra-Tite 122, Thread Locker
Medium Strength. 50 ML

KVAL P/N: LOC12250

Dust Collection



Rees-Memphis Cartridge Filter
for 7.5HP Vacuum Units

KVAL P/N: RM-CARTRIDGE



Rees-Memphis E-Band Clamp for
Model C Dust Collector

KVAL P/N: RM-56130020

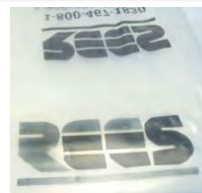

Rees-Memphis Plastic Storage
Bags 36" X 58" X 7 mm Clear
10 Bags Per Unit

KVAL P/N: RM-340536



Rees-Memphis Plastic Storage
Bags 36" X 58" X 7 mm Clear
Roll of 50 Bags

KVAL P/N: RM-340536-5

AkroBin



AkroBin, Yellow Bin, 5-1/2" Wide,
10-7/8" Deep, 5" Height.

KVAL P/N: AKR30230



AkroBin, Yellow Bin, 8-1/4" Wide,
10-3/4" Deep, 7" Height.

KVAL P/N: AKR30239



AkroBin, Yellow Bin, 8-1/4" Wide,
14-3/4" Deep, 7" Height.

KVAL P/N: AKR30240



Ball & Spring Plunger



Template Spring Plunger Fully Retractable L Shaped 1/4-20 Thread (FR-250P).

KVAL P/N: MC3403A71



Chrome Steel Ball, 1/2" Dia.

KVAL P/N: MC9528K24



Ball Plunger, 10-32 Thread, 1/2" Long, 2-5 lbs end pressure

KVAL P/N: PLUN10903



Ball Plunger, 1/4-20 Thread, 1/2" Long, 3-7 lbs end pressure

KVAL P/N: PLUN10905

Brush



Brush for Front Section Hinge Router on 990F Head

KVAL P/N: 8-00-ZZ



979/979-2 Brush and Bracket Assembly. Includes Pair of Brushes & Mounting Brackets.

KVAL P/N: 146-00-221A

Cable Carrier



TKA38.060.038.095	Tsubaki Kabelschlepp, Closed Cable Carrier 1.42" Outside Height, 2.13" Outside Width, 1.52" Pitch. 3.74" Bend Radius (Use Bracket TKA38038MBSET) Substitute for: KABP0100
TKA38.060.078.095	Tsubaki Kabelschlepp, Closed Cable Carrier 1.42" Outside Height, 3.70" Outside Width, 1.52" Pitch. 3.74" Bend Radius (Use Bracket TKA38078MBSET) Substitute for: KABP0100-078
TKA45.060.075.095	Tsubaki Kabelschlepp Closed Cable Carrier 1.97" Outside Height, 3.58" Outside Width, 1.79" Pitch. 3.74" Bend Radius. (Use Bracket TKA45075MBSET)
TKA45.060.050.095	Tsubaki Kabelschlepp Closed Cable Carrier 1.97" Outside Height, 2.59" Outside Width, 1.79" Pitch. 3.74" Bend Radius. (Use Bracket TKA45050MBSET) Substitute for: KABP0200



Cable Carrier



TKA55.060.100.120	Tsubaki Kabelschlepp Closed Cable Carrier 2.51" Outside Height, 4.72" Outside Width, 2.18" Pitch. 4.72 Bend Radius. (Use Bracket TKA55100MBSET)
TKA55.060.100.140	Tsubaki Kabelschlepp Closed Cable Carrier 2.51" Outside Height, 4.72" Outside Width, 2.18" Pitch. 5.51 Bend Radius. (Use Bracket TKA55100MBSET)
TKA55.060.125.195	Tsubaki Kabelschlepp Closed Cable Carrier 2.51" Outside Height, 5.70" Outside Width, 2.18" Pitch. 7.67 Bend Radius. (Use Bracket TKA55125MBSET)
TKA55.060.150.140	Tsubaki Kabelschlepp Closed Cable Carrier 1.77" Outside Height, 5.91" Outside Width, 2.18" Pitch. 5.51 Bend Radius. (Use Bracket TKA55150MBSET)
TKA55.060.150.300	Tsubaki Kabelschlepp Closed Cable Carrier 2.51" Outside Height, 6.69" Outside Width, 2.18" Pitch. 11.81" Bend Radius. (Use Bracket TKA55150MBSET)

Cable Carrier - Brackets



TKA38038MBSET	TSUBAKI KABELSCHLEPP Bracket for TKA38.060.038.XXX
TKA38078MBSET	TSUBAKI KABELSCHLEPP Bracket for TKA38.060.078.XXX
TKA45050MBSET	TSUBAKI KABELSCHLEPP Bracket for TKA45.060.050.XXX
TKA45075MBSET	TSUBAKI KABELSCHLEPP Bracket for TKA45.060.075.XXX
TKA55100MBSET	TSUBAKI KABELSCHLEPP Bracket for TKA55.060.100.XXX
TKA55125MBSET	TSUBAKI KABELSCHLEPP Bracket for TKA55.060.125.XXX
TKA55150MBSET	TSUBAKI KABELSCHLEPP Bracket for TKA55.060.150.XXX



Bushings



Flanged Garlock Bushing, 3/8"
I.D. - .4684 O.D. X 1/4" Long

KVAL P/N: **GAR06FDU**



Flanged Garlock Bushing, 1/2"
I.D. - .5/8" O.D. X 5/8" Long,
08FDU12

KVAL P/N: **GAR08FDU**



SF121606	OILITE, 3/8 X 1/2 X 3/8 FLANGED BUSHING 1/16 FLANGE
SF121620	OILITE, 3/8 X 1/2 X 5/8 FLANGED BUSHING 1/16 FLANGE
SF162002	OILITE 3/8 ID X 1/2 OD X 1/4 OAL 1/16 FLANGE
SF162004	OILITE, FLANGE BUSHING 1/2 X 5/8 X 1/4.
SF162006	OILITE FLANGE BUSHING 1/8 THICK FLANGE 1/2 X 5/8 X 3/8".
SF162008	OILITE 1/2 X 5/8 X 1/2 BUSHING 1/8 FLANGE
SF404816	OILITE 1-1/4 X 1-1/2 X 1 WITH FLANGE BUSHING
SF404828	OILITE 1-1/4 X 1-1/2 X 1-3/4 WITH 1/8 FLANGE BUSHING



SS061012	OILITE 3/16 X 5/16 X 3/4 SLEEVE BUSHING
SS081208	OILITE 1/4 X 3/8 X 1/4 SLEEVE BUSHING
SS121605	OILITE 3/8 X 1/2 X 5/16 SLEEVE BUSHING
SS121606	OILITE 3/8 X 1/2 X 3/8 SLEEVE BUSHING
SS121608	OILITE 3/8 X 1/2 X 1/2 SLEEVE BUSHING
SS121610	OILITE 3/8 X 1/2 X 5/8 SLEEVE BUSHING

SS121612	OILITE 3/8 X 1/2 X 3/4 SLEEVE BUSHING
SS162008	OILITE 1/2 X 5/8 X 1/2 SLEEVE BUSHING
SS162010	OILITE 1/2 X 5/8 X 5/8 SLEEVE BUSHING
SS162012	OILITE 1/2 X 5/8 X 3/4 SLEEVE BUSHING
SS162016	OILITE 1/2 X 5/8 X 1" SLEEVE BUSHING
SS162416	OILITE 1/2 X 3/4 X 1" SLEEVE BUSHING

To see our full line of products,

go to kvalinc.com and type in

collar

Find



Cam Follower



Cam Follower, 3/4 Dia., With Stud

KVAL P/N: TORCRS12



Cam Follower, 7/8 Dia., With Stud

KVAL P/N: TORCRS14



Cam Follower, 1-1/4" Dia., With Stud 1/2 NF Thread

KVAL P/N: TORCRS20



Cam Follower, 1-3/4 Dia., With Stud 3/4 NF Thread

KVAL P/N: TORCRS28



Cam Follower, 1-1/4 Dia. Without Stud

KVAL P/N: TORYCRS20

Collars



SC004F	Set Collar, One Piece, 1/4" Dia., Steel
SC005F	Set Collar, One Piece, 5/16" Dia., Steel
SC006F	Set Collar, One Piece, 3/8" Dia., Steel
SC008F	Set Collar, One Piece, 1/2" Dia., Steel
SC010F	Set Collar, One Piece, 5/8" Dia., Steel
SC012F	Set Collar, One Piece, 3/4" Dia., Steel
SC014F	Set Collar, One Piece, 7/8" Dia., Steel

SC016F	Set Collar, One Piece, 1" Dia., Steel
SC020F	Set Collar, One Piece, 1-1/4" Dia., Steel
SC024F	Set Collar, One Piece, 1-1/2" Dia., Steel



SC104F	Split Collar, One Piece, 1/4" Dia., Steel
SC106F	Split Collar, One Piece, 3/8" Dia., Steel
SC108F	Split Collar, One Piece, 1/2" Dia., Steel
SC110F	Split Collar, One Piece, 5/8" Dia., Steel
SC112F	Split Collar, One Piece, 3/4" Dia., Steel
SC116F	Split Collar, One Piece, 1" Dia., Steel
SC120F	Split Collar, One Piece, 1-1/4" Dia., Steel

SC122F	Split Collar, One Piece, 1-3/8" Dia., Steel
SC124F	Split Collar, One Piece, 1-1/2" Dia., Steel
SC132F	Split Collar, One Piece, 2" Dia., Steel



SC208F	Split Collar, Two Piece, 1/2" Dia., Steel
SC210F	Split Collar, Two Piece, 5/8" Dia., Steel
SC212F	Split Collar, Two Piece, 3/4" Dia., Steel
SC216F	Split Collar, Two Piece, 1" Dia., Steel
SC220F	Split Collar, Two Piece, 1-1/4" Dia., Steel
SC222F	Split Collar, Two Piece, 1-3/8" Dia., Steel
SC224F	Split Collar, Two Piece, 1-1/2" Dia., Steel

SC228F	Split Collar, Two Piece, 1-3/4" Dia., Steel
SC232F	Split Collar, Two Piece, 2" Dia., Steel
SC236F	Split Collar, Two Piece, 2-1/4" Dia., Steel



Air Filters



Air, Filter, Kooltronic, For Heat Exchanger, Model KXHE 120A, 5"x 9-1/2" Long

KVAL P/N: 100-3-F



Filter For Top Mount Air Conditioner, 7-1/4"X 12-1/2"

KVAL P/N: 240F



Filter For Kooltronics Air Conditioner, 8-1/2" X 16-5/8"

KVAL P/N: 8751F

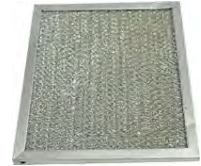

HOFFMAN Filter For AVK86 Louver Plate

KVAL P/N: AFLT86

Foam



Foam, Grabber, Foam Pad for Resting Beams, 1" Thick X 2-1/4" Wide X 35" Long

KVAL P/N: 20-00-MN



Foam, Grabber, Foam Pad for Resting Beams, 1" Thick X 5" Wide X 34" Long

KVAL P/N: 35-00-EB



Foam, Vacuum Cup Assembly, 16 Closed Cell Neoprene With Foam Disc **Substitute for: STR503016**

KVAL P/N: 24-00-80



Foam Pad Closed Cell 4"X 20" for 5125 Vacuum Cup.

Substitute for: STR5125S

KVAL P/N: 22-00-VC



Foam Disc 16" Closed Cell for 5030 Vacuum Cup

Substitute for: STR5030S2

KVAL P/N: 24-00-TB

Oil Filter



Oil Filter Cartridge Spin on 20 Microns

KVAL P/N: AE10

Step Stand



Polyethylene Two-Step Stand, Yellow, 350lbs Capacity, Used on 990-FX

KVAL P/N: MC8040T64

Hoist Ring



Hoist Ring, 2500 lbs Capacity, 360 Deg. Swivel, 180 Deg. Pivot

KVAL P/N: ADB23004

Gear Pump



Gear Motor, Hydraulic, Eaton Series 26, For Six Shooter
**6 Shooter Post 9/98

KVAL P/N: EAT21306



Hydraulic Fitting Morb # 16 x FNPT
3/4 Bushing (Used on EAT21306)

KVAL P/N: AIR64051612



Gear Pump, Hydraulic, Eaton Series 26, Model 26004, For Six Shooter

KVAL P/N: EAT26004

KIP Handles



T-Handle, for Lock Collar, 1/4-28,
Thread

KVAL P/N: 403A



Handle Bar Grips, Black, 5" Long

KVAL P/N: BIKEGRIPS



Handle, Kip 3/8-16 Female Thread
Heavy Duty, Adjustable

KVAL P/N: KIP27000



Handle, Kip 1/2-13 Female 2.25
Long Thread Heavy Duty, Adjusta-
ble

KVAL P/N: KIP27100A



Handle, Kip 5/8-11 Female
Thread Heavy Duty, Adjustable

KVAL P/N: KIP27150



Handle, Kip 10-32 Thread, 1.25
Long, Adjustable

KVAL P/N: KIP38072



Handle, Kip 1/4-20 Thread, 1.25
Long, Adjustable

KVAL P/N: KIP38102



Handle, Kip 1/4-28 Thread, 1-3/16
Long, With Stud

KVAL P/N: KIP38103



Handle, Kip 5/16-18 Thread, .78
Long, Adjustable

KVAL P/N: KIP38150



Handle, Kip 5/16-18 Thread, 1.26
Long Stud, Adjustable

KVAL P/N: KIP38152



Handle, Kip 5/16-18 Thread, 1.77
Stud, Adjustable

KVAL P/N: KIP38155



Handle, Kip 5/16-18 Thread, 1.97
Long, Adjustable

KVAL P/N: KIP38156



Handle, Kip 5/16-18 Thread, 2.48 Stud, Adjustable

KVAL P/N: **KIP38158**



Handle, Kip 5/16-18 Thread, 2.72 Stud Adjustable Handle GN300-63

KVAL P/N: **KIP38158-BS**



Handle, Kip 5/16-18 Thread, 6.00 Stud, Adjustable

KVAL P/N: **KIP38170**



Handle, Kip 3/8-16 Thread, 1.56 Stud, Adjustable

KVAL P/N: **KIP38254**



Handle, Kip 3/8-16 Thread, 1.96 Stud, Adjustable

KVAL P/N: **KIP38255A**



Handle, Kip 3/8-16 Thread, 2.36 Stud, Adjustable

KVAL P/N: **KIP38258**



Handle, Kip 3/8-16 Thread, 1.18 Long, Adjustable

KVAL P/N: **KIP38352**



Handle, Kip 1/2-13 Thread, 1.38 Long, Adjustable

KVAL P/N: **KIP38453**



Handle, Kip 1/2-13 Thread, 1.77 Stud, Adjustable

KVAL P/N: **KIP38455**



Handle, Kip 1/2-13 Thread, 2.36 Long, Adjustable

KVAL P/N: **KIP38458**



Handle, Kip 1/2-13 Thread, 1.57 Long, Adjustable

KVAL P/N: **KIP38504**



Handle, Kip 1/2-13 Thread, 2.44 Long, Adjustable

KVAL P/N: **KIP38508**



Handle, Kip 5/8-11 Thread, 1.57 Long, Adjustable

KVAL P/N: **KIP38554**



Handle, Zinc-Plated Steel Weld-in Pull Pin Non Locking With T-Handle, 1/2" Pin Dia., 1-1/2" Barrel L

KVAL P/N: **MC9022A112**



U-Handle, 20mm Dia., 3.94" Long (100mm)

KVAL P/N: **UHDL20100**



U-Handle, 26mm Dia., 7-1/2" Long (192mm)

KVAL P/N: **UHDL26192**

Bumpers



Bumpers, TecnPak Elastomer Bumper, Medium Energy Absorption, Low Reaction Force, Max. Comp. = 550 lbs.
KVAL P/N: **GBA-1075**



Bumper, Moulded Rubber, 1-1/4
KVAL P/N: **PADGBA3**

Idler Shaft



Idler Shaft, 1" Dia., 3-3/8" OAL, 3/4-10 Thread
KVAL P/N: **BRON2**



Idler Shaft, 1" Dia., 4-3/8" OAL, 3/4-10 Thread
KVAL P/N: **BRON3**

Knobs



Knob, Tapered, With 1/4 Thru Hole, 1-7/8" OAL
KVAL P/N: **KIPD1300**



Knob, Mushroom Shaped, 5/16-18 Thread, 2" Dia.
KVAL P/N: **KIPD1630**



Knob, Kip Ball For KIP27100, Handle 32mm Dia., M8 Thread
KVAL P/N: **KIPKNOB32**



Knob, DK-3, Fluted, 3/8-16 Threaded Female Insert, 1/2
KVAL P/N: **REIDK03**



Knob, DK-4 Fluted, 1/2-13 Threaded Female Insert, 5/8 Thread Depth.
KVAL P/N: **REIDK04**



Knob, DK-6, Fluted, 2-3/8" Dia. Knob, 3/8-16 Threaded, 2" Long Stud
KVAL P/N: **REIDK06**



Knob, DK-7 Fluted, 1/2-13 Stud, 1" Long
KVAL P/N: **REIDK07**



Knob, DK-8 Fluted, 1/2-13 Stud, 2" Long.
KVAL P/N: **REIDK08**



Knob, 3-Prong, 3/8-16 Thru Hole Brass Insert.

KVAL P/N: **REIDK118**



Knob, DK-25, Fluted, 3/8-16 Female Insert, 1/2" Thread Depth

KVAL P/N: **REIDK25**

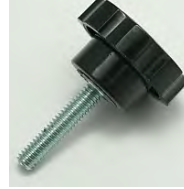

Knob, DK-27, Fluted, 1-3/4 Dia. Knob 5/16-18 Stud 1-1/2 Long.

KVAL P/N: **REIDK27**



Knob, DK-28, Fluted, 1-3/4 Dia. Knob 3/8-16 Stud 3/4-Long.

KVAL P/N: **REIDK28**



Knob, DK-29, Fluted, 1-3/4 Dia. Knob 3/8-16 Stud 1-1/2-Long.

KVAL P/N: **REIDK29**



Knob, DK-41, Knurled, 3/4 Dia. 10-32 Female Insert 5/16 Thread Depth.

KVAL P/N: **REIDK41**



Knob, DK-42, Knurled, 3/4 Dia. 1/4-20 Female Insert 5/16 Thread Depth.

KVAL P/N: **REIDK42**



Knob, DK-43, Knurled, 3/4 Dia., 10-32 Stud, 1/2 Long

KVAL P/N: **REIDK43**



Knob, DK-45, Knurled, 1/4-20 Thread 3/4 Dia. 1/2 Long Stud.

KVAL P/N: **REIDK45**



Knob, DK-46, Knurled, 3/4 Dia., 1/4-20 Stud 1" Long.

KVAL P/N: **REIDK46**



Knob, DK-54, 4-Prong, 1/4-20 Thru Hole Brass Insert

KVAL P/N: **REIDK54**



Knob, DK-55, 4-Prong, 5/16-18 Thru Hole Brass Insert.

KVAL P/N: **REIDK55**



Knob, DK-59, 4-Prong, 1-3/4 Dia., 1/4-20 X 7/16 Deep Blind Hole Brass Insert

KVAL P/N: **REIDK59**



Knob, DK-83, 4-Prong (1-1/4 Dia.) 1/4-20 X 7/16 Deep Blind Hole Brass Insert.

KVAL P/N: **REIDK83**



Knob, DK-85, 4-Prong, 1/4-20, 1-1/4 Dia. 1 Long

KVAL P/N: **REIDK85**



Knob, DK-86, 4-Prong, 1-1/4 Dia., 5/16-18 Stud 1 Long.

KVAL P/N: **REIDK86**



Knob, DK-88, 4-Prong, 2-1/4" Dia., 3/8-24 Thru Hole Brass Insert

KVAL P/N: **REIDK88**



Knob, DK-89, 4-Prong, 1/2-13 Thru Hole Brass Insert

KVAL P/N: **REIDK89**



Knob, DK-91, 4-Prong, 5/16-18 X 1/2 Deep Blind Hole Brass Insert.

KVAL P/N: **REIDK91**



Knob, DK-92, 4-Prong, 3/8-16 X 1/2 Deep Blind Hole Brass Insert.

KVAL P/N: **REIDK92**



Knob, DK-96, 4-Prong, 2-1/4 Dia., 3/8-16 Stud X 1 Long

KVAL P/N: REIDK96



Knob, DK-97, 4-Prong, 1-1/2 Long Steel Stud, 3/8-16 Thread

KVAL P/N: REIDK97



Knob, DK-98, 4-Prong, 2-1/4" Dia., 3/8-16 Stud 2" Long

KVAL P/N: REIDK98

Pads | Aluminum



Pad, Aluminum, 1" Dia., 3/8" Thick, 5/16 NF Thread

KVAL P/N: P160605FA



Pad, Aluminum 1" Dia. X 1/2" 1/4 -28 NF Thread.

KVAL P/N: P160804FA



Pad, Aluminum 1" Dia. X 1/2" 5/16 NF Thread

KVAL P/N: P160805FA



Pad, Aluminum 1" Dia. X 1/2", 7/16" NF Thread

KVAL P/N: P160807FA

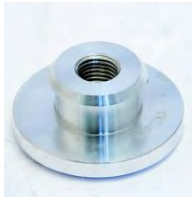

Pad, Aluminum Wheel Hub, 1-3/4 Dia. 3/4 LG 7/16 NF Thread.

KVAL P/N: P281207FH-A



Pad, Aluminum, 2" Dia., 1/2" Thick, 3/8 NC Thread

KVAL P/N: P320505-A



Knob, DK-6, Fluted, 2-3/8" Dia. Knob, 3/8-16 Threaded, 2" Long Stud

KVAL P/N: P320806CA



Pad, Aluminum, 2" Dia., 1/2" Thick, 1/2 NF Thread

KVAL P/N: P320808FA



Pad, Aluminum, 2" Dia., 1/2" Thick, 3/4 NC Thread

KVAL P/N: P320812CA



Pad, Aluminum, 3" Dia, 1/2" Thick, 7/16 NF Thread

KVAL P/N: P480807FA



Pad, Aluminum, 3" Dia, 2" Thick, 7/16 NF Thread

KVAL P/N: P483207FA



Pad, Aluminum, 3-1/2" Dia, 1/2" Thick, 5/16 NF Thread

KVAL P/N: P560805FA



Pad, Aluminum 3-1/2" Dia. X 1/2" 3/8" NC Thread

KVAL P/N: P560806CA



Pad, Aluminum, 3-1/2" Dia, 1/2" Thick, 1/2 NF Thread

KVAL P/N: P560808FA



Pad, Aluminum, 3-1/2" Dia, 1/2" Thick, 3/4 NC Thread

KVAL P/N: P560812CA



Pad, Aluminum, 6" Dia, 5/8 Thick, 3/8 NC Thread

KVAL P/N: P961012CA

Pads | Delrin



Pad, Clamp Pad, Up-clamp, UHMWP, 1-3/4" Dia. X 9/16

KVAL P/N: 42-00-L13



Pad, Delrin, 1-3/4" Dia, 1-9/16" Thick, 7/16 NF Thread

KVAL P/N: 65-00-J1



Pad, Delrin, 3/4" Dia. X 1-1/4", 5/16 NF Thread

KVAL P/N: P122005FD

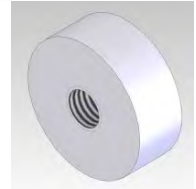

Pad, Delrin, 1" Dia. X 3/8" 5/16 NF Thread

KVAL P/N: P160605FD



Pad, Delrin, 1" Dia. X 7/16", 3/8" Drill

KVAL P/N: P160706-D



Pad, Delrin, 1" Dia. X 1/2" 1/4-28 NF Thread

KVAL P/N: P160804FD



Pad, Delrin, 1" Dia. X 1/2" 5/16 NF Thread.

KVAL P/N: P160805FD



Pad, Delrin, 1" Dia. X 1/2", 3/8" NC Thread, DL-2 Arbor Drive Belt

KVAL P/N: P160806CD



Pad, Delrin 1" Dia. X 1/2" 7/16 NF Thread.

KVAL P/N: P160807FD



Pad, Delrin 1" Dia. X 5/8", 1/4-28" NF Thread

KVAL P/N: P161004FD



Pad, Aluminum 1" Dia. X 3/4", 5/16-18" Thread

KVAL P/N: P161205CD



Pad, Delrin 1" Dia. X 3/4" Thick, 3/8" ID

KVAL P/N: P161222D

To see our full line of products,

go to kvalinc.com and type

Pad

Find



Pad, Delrin, 1" Dia. X 1" Thick, 1/4-28 NF Thread

KVAL P/N: **P161604FD**



Pad, Delrin 1" Dia. X 1" 5/16" NF Thread

KVAL P/N: **P161605FD**



Pad, Delrin, 1" Dia. X 1" Thick, 3/8 NC Thread

KVAL P/N: **P161606CD**



Pad, Delrin, 1" Dia. X 7/16" NF Thread

KVAL P/N: **P161607FD**



Pad, Delrin 1" Dia. X 1-3/4" 5/16 NF Thread

KVAL P/N: **P162805FD**



Pad, Delrin 1" Dia. X 1-3/4" 7/16 NF Thread

KVAL P/N: **P162807FD**



Pad, Delrin 1" Dia. X 2-1/4" Thick, 7/16 NF

KVAL P/N: **P163607FD**



Pad, Delrin 1-1/4" Dia. X 1/2" 5/16" NF Thread

KVAL P/N: **P200805FD**



Pad, Delrin 1-1/2" Dia. X 1/2" 7/16 NF Thread

KVAL P/N: **P240807FD**



Pad, Delrin 1-1/2" Dia. X 5/8" Thick., 7/16 NF Thread

KVAL P/N: **P241007FD**



Pad, Delrin 1-1/2" Dia. X 1" 5/16" NF Thread

KVAL P/N: **P241605FD**



Pad, Delrin 1-1/2" Dia. X 1" 7/16 NF Thread

KVAL P/N: **P241607FD**



Pad, Delrin 1-3/4" X 3/8" 7/16 NF Thread

KVAL P/N: **P280607FD**



Pad, Delrin 1-3/4" Dia. X 1/2" 5/16 NF Thread

KVAL P/N: **P280805FD**



Pad, Delrin, 1-3/4" Dia., 1/2" Thick, 1/2 NF Thread

KVAL P/N: **P280808FD**



Pad, Delrin, 1-3/4" Dia., 3/4" Thick, 5/16 NF Thread

KVAL P/N: **P281205FD**



Pad, Delrin 1-3/4" Dia X 3/4" 7/16 NF Thread

KVAL P/N: **P281207FD**



Pad, Delrin 1-3/4" Dia. X 3/4" Long, 3/4-10 NC Thread, Special

KVAL P/N: **P281212FH**



Pad, Delrin, 1-3/4" Dia, 1-1/2" Thick, 5/16 NF Thread

KVAL P/N: **P282405FD**



Pad, Delrin, 2" Dia, 1/2" Thick, 13/32 Drill Countersink

KVAL P/N: **P320805-D**



Pad, Delrin, 2" Dia, 1/2" Thick, 7/16 NF Thread

KVAL P/N: P320807FD



Pad, Delrin 2" Dia. X 1", 11/32 DR & CSK

KVAL P/N: P321605-D



Pad, Delrin, 2-1/2" Dia., 1/2" Thick, 13/32 Drill Countersink

KVAL P/N: P400805-D



Pad, Hub, 2-3/4" Dia X 7/8 LG, 3/4 NC Thread, For 1-3/8 ID Green Wheel

KVAL P/N: P441312CD



Pad, Delrin, 3" Dia, 1/2" Thick, 7/16 NF Thread

KVAL P/N: P481607FD



Pad, Delrin, 3-1/2" Dia, 3/4" Thick, 3/4-10 Thread

KVAL P/N: P561212CD

Pads | Felt



Pad, Felt 1" Dia X 1/8".

KVAL P/N: P160200-F



Pad, Felt 1" Dia X 1/2"

KVAL P/N: P160800-F



Pad, Felt, 1/4" X 1" X 2"

KVAL P/N: P163204-F



Pad, Felt, 1-1/4" Dia X 1/8".

KVAL P/N: P200200-F



Pad, Felt, 1-1/2" Dia X 1/2" Thick

KVAL P/N: P240800-F



Pad, Felt, 1-3/4" Dia X 1/8"

KVAL P/N: P280200-F



Pad, Felt, 1-3/4" Dia X 1/2" Thick

KVAL P/N: P280800-F



Pad Felt "L" Shape 1/8 X 1-3/4 X 3

KVAL P/N: P284802-F



Pad, Felt, 2" Dia X 1/8"

KVAL P/N: P320200-F



Pad, Felt, 2" Dia X 1/2"

KVAL P/N: P320800-F



Pad, Felt, 2-3/4" Dia X 1/4"

KVAL P/N: P440400-F



Pad, Felt, 3" Dia X 1/2"

KVAL P/N: P480800-F



Pad, Felt, 3-1/2" Dia X 1/8"

KVAL P/N: P560200-F



Pad, Felt, 3-1/2" Dia X 1/2"

KVAL P/N: P560800-F

Pads | Rubber



Pad, Rubber, White, 5/8" I.D. X 1-1/8" Long

KVAL P/N: CP10



Pad, 60 Duro Green, 3-15/16 X 1-7/8 Molded with Steel Insert.

KVAL P/N: P633006-N

Pads | Foam

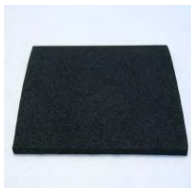

Pad, Black Foam, 6" X 6" X 3/8" Used on ON-1 & ON-2

KVAL P/N: P969606-R



Pad, Black Foam, 8" Diameter x 1" Thick for RKG-4

KVAL P/N: 98-00-FP

Pads | Leveling



Leveling Pad, 1/2 X 3 X 3

KVAL P/N: 216C



Pads | Top Belting



Pad, Green, 1" Dia, 3/16" Pic 50
Rough Top Belting

KVAL P/N: P160300-R



Pad, Green, 1-1/2" Dia, 3/16" Pic 50
Rough Top Belting

KVAL P/N: P240300-R



Pad, Green, 1-3/4" Dia, 3/16" Pic 50
Rough Top Belting

KVAL P/N: P280300-R



Pad, Green, 2" Dia, 3/16" Pic 50
Rough Top Belting

KVAL P/N: P320300-R



Pad, Green, 3" Dia, 3/16" Pic 50
Rough Top Belting, For Cylinder
Pad

KVAL P/N: P480300-R



Pad, Green, 3-1/2" Dia, 3/16" Pic 50
Rough Top Belting

KVAL P/N: P560300-R



Pad, Green, 6" Dia, 3/16" Pic 50
Rough Top Belting

KVAL P/N: P960300-R

Pressure Gauge



Mist Gauge for the Generator

KVAL P/N: WAL382064



Pressure Gauge, Stauff SPG-063
-01000-5-S-N04,6 Shooter Tank

KVAL P/N: WIK2153



Vacuum Gauge 50MM WorkSmart - 2 Inch Dial,
1/4 Inch NPT, 30 to 0 Scale Range Pressure
Gauge ABS Case, Brass Wetted Parts, Bronze
Bourdon Tube, Lower Connection Mount. (SL-1,
SL-2 & ON-2) **Substitute for: GRA4FLT5**

KVAL P/N: WSPEGAUGE20

Rail Standoff



Shaft Support, 1 inch Diameter
Standoff

KVAL P/N: 526C



Shaft Support, 1 1/2 inch Diameter
Standoff

KVAL P/N: 527C



Shaft Support, 3/4 inch Diameter
Standoff

KVAL P/N: 539C

To see our full line of products,

go to kvalinc.com and type

Rod ends

Find

Rod End



Rod End Male, TRE-3, 10-32 Bore, Male 10-32 Thread Shank End

KVAL P/N: **RODEND03M**



Rod End Female, TRE-5, 5/16 Bore, 5/16-24 Thread Shank End

KVAL P/N: **RODEND05F**



Rod End Male, TRE-5, 5/16 Bore, 5/16-24 Male Thread Shank End

KVAL P/N: **RODEND05M**



Rod End Male, High Strength PTFE Lined Ball Joint, 5/16 Bore, 5/16-24 Male Threaded Shank, Alloy Steel

KVAL P/N: **RODEND05MAS**



Rod End Female, TRE-6, 3/8 Bore, 3/8-24 Thread Shank End

KVAL P/N: **RODEND06F**



Rod End Male, TRE-6, 3/8 Bore, 3/8-24 Male Thread Shank End

KVAL P/N: **RODEND06M**



Rod End Female, TRE-7, 7/16 Bore, 7/16-20 Thread Shank End

KVAL P/N: **RODEND07F**



Rod End Male, TRE-7, 7/16 Bore, Male 7/16-20 Thread Shank End

KVAL P/N: **RODEND07M**



Rod End Female, TRE-8, 1/2 Bore, 1/2-20 Thread Shank End

KVAL P/N: **RODEND08F**

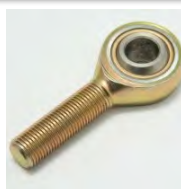

Rod End Male, TRE-8, 1/2 Bore, Male 3/8-24 Thread Shank End

KVAL P/N: **RODEND08M**



Rod End Male, TRE-10, 5/8 Bore, Male 5/8-18 Thread Shank End

KVAL P/N: **RODEND10M**



Rod End Female, TRE-12, 3/4 Bore, 3/4-16 Thread Shank End

KVAL P/N: **RODEND12F**



Rod End Male, TRE-12, 3/4 Bore, Male 3/4-16 Thread Shank End

KVAL P/N: **RODEND12M**



Rod End Male, TRE-12, 3/4 Bore, Male 3/4-16 Thread Shank End, Left Hand

KVAL P/N: **RODEND12M-LH**



Rod End Male, 3/8-24 NF Left Hand

KVAL P/N: **RODENDCB6**



Rolls



Conveyor Axle Support Bracket, 2 Hole, 7/16 Hex

KVAL P/N: PACBRKT



KVAL P/N: See Table

RALROLL39NG	Roll 2-1/2"OD 38-7/8"LG No Groove
RALROLL42NG	Roll 2-1/2"OD 41-7/8"LG No Groove
RALROLL52NG	Roll 2-1/2"OD 51-7/8"LG 2-Groove

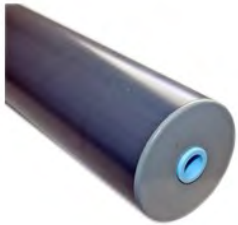

KVAL P/N: See Table

RAL312008	Roll Plastic, 3-1/2" Dia X 8" Long, 5/8" ID
RAL312012	Roll Plastic, 3-1/2" Dia X 12" Long, 5/8" ID
RAL312016	Roll Plastic, 3-1/2" Dia X 16" Long, 5/8" ID
RAL312020	Roll Plastic, 3-1/2" Dia X 20" Long, 5/8" ID
RAL312024	Roll Plastic, 3-1/2" Dia X 24" Long, 5/8" ID
RAL312039	Roll Plastic, 3-1/2" Dia X 39" Long, 5/8" ID
RAL312044	Roll Plastic, 3-1/2" Dia X 44" Long, 5/8" ID
RAL312052	Roll Plastic, 3-1/2" Dia X 52" Long, 5/8" ID



Conveyor Spool, 1" I.D., Sierre Spool

KVAL P/N: SIESP094A



KVAL P/N: See Table

RALROLL39	Roll 2-1/2"OD 38-7/8"LG 2-Groove
-----------	----------------------------------



KVAL P/N: See Table

RALROLL39A	Roll 2-1/2"OD 38-7/8"LG 1-Groove
RALROLL42A	Roll 2-1/2"OD 41-7/8"LG 1-Groove

Self Aligning Coupler



Rod Alignment Coupler, 1/2-20 Threads, 2° of Misalignment, Steel

KVAL P/N: MC6184K44



Rod Alignment Coupler, 3/4-10 Threads, 2° of Misalignment, Steel

KVAL P/N: MC6184K51



Rod Alignment Coupler, 3/8-24 Threads, 2° of Misalignment, Steel

KVAL P/N: PHD375



Rod Alignment Coupler, 7/16-20 Threads, 2° of Misalignment, Steel

KVAL P/N: PHD437

Shock Absorber



Shock, Jamb Nut For OEM .25 Enidine Shock, 1/2-20 UNF Thread.

KVAL P/N: ENINUT01



Shock, Jamb Nut for OEM .50 Enidine Shock, 3/4-16 UNF Thread.

KVAL P/N: ENINUT02



Shock, Jamb Nut For OEM 1B Enidine Shock, 1-12 UNF Thread., Grade 5

KVAL P/N: ENINUT03

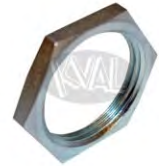

Shock, Jamb Nut For OEM 1.25 Enidine Shock, 1-3/8 UNF Thread.

KVAL P/N: ENINUT04



Shock Enidine OEM .25B 1/2-20 Thread 3/8 Stroke

KVAL P/N: ENIOEM025



Shock Enidine OEM .50B 3/4-16 Thread 1/2 Stroke.

KVAL P/N: ENIOEM050



Shock Enidine OEM 1B 1 Stroke

KVAL P/N: ENIOEM10B



Shock Enidine OEM 1.25 X 2" Stroke with C98609079 Cap

KVAL P/N: ENIOEM125



Shock, End Cap for ENIOEM10B, 1Q2587250

KVAL P/N: ENIOEMCAP



SHOCK ABSORBER, GAS OPERATED, KYB-5406

KVAL P/N: KYBKG5406



Spiral Wrap



SR-NAT0375	3/8 OD Natural Spiral Wrap. 3" Diameter
SR-NAT0500	1/2 OD Natural Spiral Wrap. 4" Diameter
SR-NAT0750	3/4 OD Natural Spiral Wrap. 5" Diameter
SR-NAT1000	1" OD Natural Spiral Wrap. 7" Diameter

Springs

Spring 32 Wire With Looped Ends for 990F Chipout Vertical Movement.
KVAL P/N: **080111LX**

Spring, 1/4" OD X .18" ID X 1-11/32" Long, .035 Wire With looped ends
KVAL P/N: **080111LY**

Spring .035 Hopper W L/E DBL Loop Ends 90 DEG (Screw Hopper) SPG 0200.
KVAL P/N: **080200L**

Spring, 1/4" OD X 3/16" ID X 5" Long, .032 Wire With looped ends
KVAL P/N: **080500L**

Spring, 5/16" OD X 3/16" ID X 1" Long, .0475 Wire With C/E
KVAL P/N: **100100C**

Spring, 5/16" OD X 1/4" ID X 5" Long, .032 Wire With Looped Ends
KVAL P/N: **100500L**

Spring, 3/8" OD X 9/32" ID X 1-3/4" Long, .035 Wire With Coiled Ends
KVAL P/N: **120124C**

Spring, 3/8" OD X 1/4" ID X 2-1/4" Long, .0625 Wire With Coiled Ends
KVAL P/N: **120208C**

SPRING, 3/8-OD X 3/16-ID X 4 LONG SPRING, .052 WIRE WITH 1-HOOK, DOUBLE HOOK
KVAL P/N: **120400HL**

Spring 13/32-OD X 1/4-ID X 1-3/4 Long .0625 Wire with Coiled Ends
KVAL P/N: **130124C**

Spring, 7/16" OD X 5/16" ID X 2" Long, .0625 Wire With Coiled Ends
KVAL P/N: **140200C**

Spring, 7/16" OD X 5/16" ID X 3-1/2" Long, .054 Wire With Hooked Ends
KVAL P/N: **140316H**

To see our full line of products,

go to kvalinc.com and type in

Springs

Find



Spring 1/2-OD 7/16-ID 1/4 Turret Long .048 W C/G Turret Spring. 1-3/4 Long

KVAL P/N: 160008A



Spring, 1/2" OD X 3/8" ID X 3" Long, .0475 Wire With Coiled Ends

KVAL P/N: 160300C



Spring 9/16-OD 2-3/8 X 3/8 ID .080 Wire C/G

KVAL P/N: 180212A



Spring, 9/16" OD X 3/8" ID X 4-1/2" Long

KVAL P/N: 180416H



Spring, 5/8" OD X 1/2" ID X 2-3/4 Long, .054 Wire With Coiled Ends

KVAL P/N: 200224C



Spring 11/16-OD X 1/2-ID X 1-3/8 Long, Lower Spring for SL-1 Vacuum Cup.

KVAL P/N: 220112L



Spring, 11/16" OD X 5-5/8" Long, .091 Wire L/E

KVAL P/N: 220520L



Spring, 3/4" OD X 1/2" ID X 3-1/4" Long, .105 Wire C/G

KVAL P/N: 240308A



Spring, 3/4 OD X 9/16 ID X 3-1/2" Long, .080 Wire Coil Ground

KVAL P/N: 240316B



Spring, 13/16-OD X 1/2-ID X 1-1/8 Long, .125 with Coil Ground Upper Spring 5030 Vacuum Cup for SL-1

KVAL P/N: 260104A



Spring, 13/16" OD X 11/16" ID X 3-1/2" Long, .049 Wire C/G

KVAL P/N: 260316A



Spring, 13/16" OD X .6525" ID X 8-1/2" Long, .080 Wire With Hooked Ends

KVAL P/N: 260816H

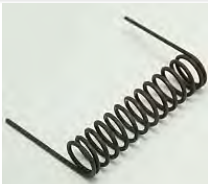

Spring, 7/8" OD X 5/8" ID X 3-1/4" Long, 1-1/2" Long Ends Straight Out

KVAL P/N: 280308E



Spring, 7/8" OD X 11/16" ID X 3-1/2" Long, Coil Ground

KVAL P/N: 280316A



Spring, 7/8" OD X 9/16" ID X 6" Long, .120 Wire C/G

KVAL P/N: 280600A



Spring, 1" OD X 25/32" ID X 6" Long, .175 Wire C/G

KVAL P/N: 320600A



Springs



Spring, 1-OD 13/16-ID 8-1/2" Long, 990 .120 Wire Hooked Ends

KVAL P/N: 320816H



Spring, 1-1/16" OD X 13/16" ID X 8" Long, 29 Coils

KVAL P/N: 340800A



Spring, 1-1/8-OD X 13/16-ID X 2-7/8 Long

KVAL P/N: 360228A



Spring, 1-1/8-OD X 3/4-ID X 4-3/4 Long with Hooked Ends

KVAL P/N: 360424H



Spring, 1-1/8" OD X 3/4" ID X 6" Long, C/G

KVAL P/N: 360600AB



Spring, 1-1/8" OD X 3/4" ID X 10" Long, .148 Wire Coarse Ground

KVAL P/N: 361000A



Spring 1-3/16-OD X 7/8-ID X 12 Long, .162 Wire Hooked Ends

KVAL P/N: 381200H



Spring, 1-1/4" OD X 2" Long, .090 Wire Coarse Ground

KVAL P/N: 400200A



Spring, 1-1/4" OD X 15/16" ID X 3-3/4" Long, Looped Ends

KVAL P/N: 400324L



Spring, 1-1/4" OD X 1" ID X 4-1/2" Long, .093 Wire Coil Ground

KVAL P/N: 400416A



Spring, 1-1/4" OD X 1" ID X 6-1/2" Long, .093 Wire Coil Ground

KVAL P/N: 400616A



Spring, 1-1/4" OD X 7/8" ID X 7-1/4" Long, .162 Wire Hooked End

KVAL P/N: 400708H



Spring, 1-1/4" OD X 1" ID X 9" Long, .1 End Closed, 1 End Straight out 90 Deg.

KVAL P/N: 400900CF



Spring, 1-1/4" OD X 1" ID X 12" Long, Torsion Spring Ends Straight out 90 Deg

KVAL P/N: 401200F



Spring, 1-1/4" OD X 7/8" ID X 12" Long, .162 Wire, Double Loop Each End

KVAL P/N: 401200LD



Spring, 1-5/16" OD X 13/16" ID X 8" Long, .225 Wire, With Hooked Ends

KVAL P/N: 420800H

To see our full line of products,

go to kvalinc.com and type in

springs

Find



Spring, 1-5/16" OD X 1" ID X 12" Long, .135 Wire, With Hooked Ends

KVAL P/N: 421200H



Spring, 1-3/8" OD X 11/16" ID X 8" Long, .190 Wire, With C/G

KVAL P/N: 440800A



Spring, 1-5/8" OD X 1-1/8" ID X 8" Long, With 1 end C/G, 1 End Closed

KVAL P/N: 520800AC



Spring, 1-3/4" OD X 1-1/4" ID X 8" Long, C/G

KVAL P/N: 560800A



Spring, 1-3/4" OD X 1-1/4" ID X 12-3/4" Long, .207 Wire C/G, 59 Coils

KVAL P/N: 561224A



SPRING 1-25/64-OD 7" LG 7/8-ID .207 W C/G BPR SPG 110SAW K-17 SPG0702

KVAL P/N: 570700A



MDA-3, Spring, Tilt up Cylinder, 1-3/4 OD X 3

KVAL P/N: 87-00-8C



Spring 1.75 OD 14 Long Swivel Enclosed Hook Both Ends 207 Wire Dia. (990 F4 Front Section, Vertical)

KVAL P/N: CENT10810



Spring, 1-1/2" OD X 19-3/8" Long .162 Wire. 4.03 LBS Per Inch 83.60 Load (SPC-10606) (990-FX Upper Spring)

KVAL P/N: CENT326



Spring, 3/8" OD, 36" Long, .035 Wire, 8 Coils per each

KVAL P/N: LANE1440



Spring, 1-1/16" OD, 12" Long, .135 Wire, 10.5" Stretch 7.775 Lbs/Inch, 18 Initial Tension

KVAL P/N: LANE728



Spring, 1/4" OD, 4" Long, .032 Wire, Zinc Plated

KVAL P/N: MC9654K167



Spring 12 Long 1-3/16 O.D. .135 Wire Hooks Both Ends # 634 (Vertical Movement for Heads on 990F2 & Early 990F-3, pre 1995)

KVAL P/N: SPG381229H



Spring, 1/2-ID X 1-1/16 Long, 74' Series, .052 Wire, 6 Coils, Ground Ends

KVAL P/N: KVASPR01



Spring, 19/32ID X 1-1/16 Long, 74' Series, .062 Wire, 6 Coils, Ground Ends (6 Shooter, BF-3)

KVAL P/N: KVASPR02



Spring, 19/32-ID X 7/8 Long, .062 Wire, 5 Coils, Ground Ends (990-FX Only)

KVAL P/N: KVASPR03



Stop Pins | Solid



KVAL P/N: See Table

STOP1402	Stop Pin, 1/16 X 1/4 Shank
STOP1404	Stop Pin, 1/8 X 1/4 Shank
STOP1406	Stop Pin, 3/16 X 1/4 Shank
STOP1408	Stop Pin, 1/4 X 1/4 Shank
STOP1410	Stop Pin, 5/16 X 1/4 Shank
STOP1412	Stop Pin, 3/8 X 1/4 Shank
STOP1414	Stop Pin, 7/16 X 1/4 Shank
STOP1416	Stop Pin, 1/2 X 1/4 Shank
STOP1418	Stop Pin, 9/16 X 1/4 Shank
STOP1420	Stop Pin, 5/8 X 1/4 Shank
STOP1422	Stop Pin, 11/16 X 1/4 Shank
STOP1423	Stop Pin, 23/32 X 1/4 Shank

STOP1442	Stop Pin, 1-5/16 X 1/4 Shank
STOP1444	Stop Pin, 1-3/8 X 1/4 Shank
STOP1446	Stop Pin, 1-9/16 X 1/4 Shank
STOP1470	Stop Pin, 1/8 X 1/4 Shank Stress Proof
STOP1471	Stop Pin, 1/4 X 1/4 Shank Stress Proof
STOP1472	Stop Pin, 3/8 X 1/4 Shank Stress Proof
STOP1832	Stop Pin, 9/16 X 1" Long, 1/4 Shank

Storage



Adjustable Compartment Box, For Small Sliding Drawer Parts Cabinet, With Catch, Dividers

KVAL P/N: GRA3KP98

STOP1424	Stop Pin, 3/4 X 1/4 Shank
STOP1425	Stop Pin, 25/32 X 1/4 Shank
STOP1426	Stop Pin, 13/16 X 1/4 Shank
STOP1427	Stop Pin, 27/32 X 1/4 Shank
STOP1428	Stop Pin, 7/8 X 1/4 Shank
STOP1429	Stop Pin, 29/32 X 1/4 Shank
STOP1430	Stop Pin, 15/16 X 1/4 Shank
STOP1431	Stop Pin, 31/32 X 1/4 Shank
STOP1432	Stop Pin, 1 X 1/4 Shank
STOP1433	Stop Pin, 1-1/32 X 1/4 Shank
STOP1434	Stop Pin, 1-1/16 X 1/4 Shank
STOP1436	Stop Pin, 1-1/8 X 1/4 Shank
STOP1438	Stop Pin, 1-3/16 X 1/4 Shank
STOP1440	Stop Pin, 1-1/4 X 1/4 Shank

STOP3802	Stop Pin, 1/16 X 3/8 Shank
STOP3804	Stop Pin, 1/8 X 3/8 Shank
STOP3816	Stop Pin, 1/2 X 3/8 Shank
STOP3822	Stop Pin, 11/16 X 3/8 Shank
STOP3824	Stop Pin, 3/4 X 3/8 Shank
STOP3832	Stop Pin, 1" X 3/8 Shank
STOP3836	Stop Pin, 1-1/8 X 3/8 Shank

Threaded Pin Holders



STOP-PIN HOLDER, 1/2-13 THREAD X 1-7/8 LONG WITH INTERNAL O RING.

KVAL P/N: PINHLDR1



STOP-PIN HOLDER, 1/2-13 THREAD X 1" LONG WITH INTERNAL O RING.

KVAL P/N: PINHLD-DDB

Stop Pins | Telescoping



KVAL P/N: See Table Below

TELESTOP1	Telescoping Pin, 1", 1/4" Shank
TELESTOP2	Telescoping Pin, 2", 1/4" Shank
TELESTOP3	Telescoping Pin, 3", 1/4" Shank
TELESTOP4	Telescoping Pin, 4", 1/4" Shank

Threaded Female Stop Pins



KVAL P/N: See Table

STOP1432C	Stop Pin, 1" Long, 1/4-20 Female Thread, 1/4" Shank
STOP1464C	Stop Pin, 2" Long, 1/4-20 Female Thread, 1/4" Shank

To see our full line of products,

go to kvalinc.com and type in

Tape

Find



Tape Reader



Tape, Refill 10' Long, 1/4 Wide

KVAL P/N: LUFW6110



Ruler, Aluminum, 1" Wide X 36" Long, Reads Left to Right

KVAL P/N: RULE1636-L



Ruler, Aluminum, 1" Wide X 36" Long, Reads Right to Left

KVAL P/N: RULE1636-R



Ruler, 1-1/2" x 38", Plastic Adhesive backed reading Left to Right 16-52, White/Green/Red Graphics, 1" blank at Ends, Top Coated.

KVAL P/N: RULE1652



Tape, 12' Stick-Down 1/2 Wide Reads R-L

KVAL P/N: TAPE12-RL



Tape 12' Stick-Down 1/2 Wide Reads L-R

KVAL P/N: TAPE12-LR

Tensioner



Base Tensioner, Modified SE15, Tapped 3/8-16NC

KVAL P/N: LOVSE15M



Tensioner Device, ROSTA, SE-F27, Lovejoy

KVAL P/N: LOVSE27

Toggle Clamp



Toggle Clamp, Hold Down Vertical Handle, 52010

KVAL P/N: DES201



Clamp, Flat-Tip Bonded Neoprene Cap, EDP, 1/4-20 Thread 1-5/8" OAL, 59803

KVAL P/N: DES202208



Clamp, Swivel Foot 2-3/8 Long, 1/4-20 Thread Manual Clamp

KVAL P/N: DES207206



Clamp, Red Poly Cap Flat Tip, 1/4-20 Female Thread

KVAL P/N: DES215219



Toggle Clamp



Toggle Clamp, Hold Down, 215-U, 5-7/16" Long, 1-1/2" High, 52150

KVAL P/N: DES215U



Clamp, Flat-Tip Bonded Neoprene Cap, 5/16-18 Male Thread 2-1/4" OAL

KVAL P/N: DES225208



Toggle Clamp, Hold Down, Solid Bar Drop Handle, 53171

KVAL P/N: DES317S



Clamp, DESTACO Flanged Washer For 807-UL arm

KVAL P/N: DES507107



Clamp, Adjustable Spindle, 2-3/8" Long, 5/16-18 Thread

KVAL P/N: DES507206



Clamp, Spindle Assembly 3" Long 5/16-18 Male

KVAL P/N: DES507208



Toggle Clamp, Hold Down, Solid Bar Drop Handle, 55275

KVAL P/N: DES527F



Toggle Clamp 2-3/8 Long 1/4-20 Female Thread (56020).

KVAL P/N: DES602



Toggle Clamp, Model 56040, 4-3/4" Long, 5/16-18 Female Thread

KVAL P/N: DES604



Straight Line Action Clamp 8.5 OAL Manual Action

KVAL P/N: DES615



Toggle Clamp Pneumatic Hold Down 9-1/4 Long 3 High (960-3)

KVAL P/N: DES807-U



Toggle Clamp Hydraulic Hold Down, 16-5/16 Long 4-1/2 High, 847-S

KVAL P/N: DES847S

Wheels



Wheel, V-Groove Wheel Assembly with Grease able Axle

KVAL P/N: INC3150UGRB-A



Wheel, V-Groove Wheel Assembly (Pre 2003) Non Grease able Axle, Uses Cap Screw 1/2-13 X 3-1/4 Long

KVAL P/N: INC3150UGRB-C



Wheel Spacer Reducer For Handler V-Groove Wheel, 1/2 X 3/4 X 2-1/4 Long

KVAL P/N: ZF081236



Grease able Axle For Handler V-Groove Wheel

KVAL P/N: ZJ085408

To see our full line of products,

go to kvalinc.com and type

wheels

Find



WHEEL, 3" DIA. X 1-1/4" WIDE
3/8" ID WHEEL WITH SIMI-
PRECISION ROLLER BEARING

KVAL P/N: **INDXS0303106**



WHEEL, 4" DIA. X 1-1/4" WIDE
3/8" ID WITH SIMI-PRECISION
ROLLER BEARING

KVAL P/N: **INDXS0403106**



Handle, For Handwheel, 3", 3/8-16
Male Revolving Handle

KVAL P/N: **JER21904**



Handwheel, 6" Dia., 3 Spoke ,
Aluminum, Without Handle,
14ME87A

KVAL P/N: **JER22101**



Handwheel, 8" Dia., 3 Spoke ,
Aluminum, Without Handle,
18ME89A

KVAL P/N: **JER22102**



Handwheel, 6" Dia, Bore Modified
to 5/8" Dia., 3 Spoke Aluminum,
Comes with Handle

KVAL P/N: **JER22301M**



Handwheel, 10" Dia., 3 Spoke ,
Aluminum, With Handle, 22ME91A

KVAL P/N: **JER22303**



Handwheel, With Handle, 4" Dia, 3
Spoke Aluminum, 10ME84D

KVAL P/N: **JER22308**



Wheel, REVVO Caster Wheel, 4" dia.,
5/8" ID, with Frame 5" Height
Substitute for: **REVMT4100 &
REVTS100CP04**

KVAL P/N: **REV411PSBW**



REVVO 4 GRAY WHEEL ON-
LY .475 ID

KVAL P/N: **REV100CP04**



Handle, For 4" HandWheel
10ME84D

KVAL P/N: **JER22308-H**



Wheel, Caster Swivel Rubber 2"
Dia with 3/8-NC X 1-1/4 Stud.
Substitute for: **INDTP30202-24-MIR**

KVAL P/N: **INDTP3020-28-MIR**



Wheel, Poly Red, 3" Dia X 1-1/4"
Wide, 1/2" ID Ball Bearing. Use
with 1/2 OD Sleeve # RNK310002

KVAL P/N: **RNK310002**



Tire Yellow 6-1/4 OD, 2-3/4 ID,
2 Wide 70 Duro

KVAL P/N: **WES104T01**



Wheel, Roller Green Polytube, 4-3/8" OD X 1-3/8" ID X 1" LG, 60 Duro

KVAL P/N: WESPT11135X1.0



Roller Green Polytube 1-1/2 Dia X 7/16 Wide X 7/8 ID 60 Duro.

KVAL P/N: WESPT3822



Roller Green Polytube 2 Dia X 7/16 Wide 7/8-ID 60 Duro

KVAL P/N: WESPT5107



Roller Green Polytube 2 Dia X 3/4 Wide 7/8-ID 60 Duro

KVAL P/N: WESPT5112



Roller Green Polytube, 3" O.D. X 1-3/8" I.D. X 3/8" Wide, 60 Duro

KVAL P/N: WESPT7606



Roller Green Polytube, 3" O.D. X 1-3/8" I.D. X 1/2" Wide, 60 Duro

KVAL P/N: WESPT7608



Roller Green Polytube 3 Dia X 3/4 Wide 1-3/8-ID 60 Duro

KVAL P/N: WESPT7612



Roller Green Polytube, 3" O.D. X 1-3/8" I.D. X 1-1/4" Wide, 60 Duro

KVAL P/N: WESPT7620



Roller Green Polytube, 3" O.D. X 1-3/8" I.D. X 1-3/8" Wide, 60 Duro

KVAL P/N: WESPT7624



Roller Green Polytube, 3" O.D. X 1-3/8" I.D. X 3" Wide, 60 Duro

KVAL P/N: WESPT7648



Roller Green Polytube, 3-3/8" O.D. X 2-7/32" I.D. X 7/16" Wide, 60 Duro

KVAL P/N: WESPT8518



Wheel, Roller Green Polytube, 3.3465" OD X 1-3/8" ID X 3/4" LG, 60 Duro

KVAL P/N: WESPT8535075



Roller Green Polytube, 3-5/8" OD X 1-3/8" ID X 1-1/2" LG, 60 Duro

KVAL P/N: WESPT9224



Roller Green Polytube, 3-5/8" OD X 1-3/8" ID X 2" LG, 60 Duro

KVAL P/N: WESPT9232



Roller Green Polytube 4-3/8" OD X 1-3/8" ID X 1-7/8 LG 60 Duro

KVAL P/N: WESPT9241

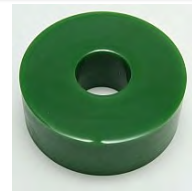

Wheel, Roller Green Polytube, 4" OD X 1-3/8" ID X 1-1/2" LG, 60 Duro

KVAL P/N: WESPT9248

Eye Bolt



Eye Bolt, 5/16-18 Thread, 1" Long

KVAL P/N: EB312100

Flat Head Socket Head



5/16-18 UNC

312CFS050	Fasteners, Flat Head,5/16-18 X 1/2", Grade 8
312CFS062	Fasteners, Flat Head,5/16-18 X 5/8", Grade 8
312CFS075	Fasteners, Flat Head,5/16-18 X 3/4", Grade 8
312CFS087	Fasteners, Flat Head,5/16-18 X 7/8", Grade 8
312CFS100	Fasteners, Flat Head,5/16-18 X 1", Grade 8
312CFS125	Fasteners, Flat Head,5/16-18 X 1-1/4", Grade 8
312CFS150	Fasteners, Flat Head,5/16-18 X 1-1/2", Grade 8
312CFS175	Fasteners, Flat Head,5/16-18 X 1-3/4", Grade 8
312CFS200	Fasteners, Flat Head,5/16-18 X 2", Grade 8
312CFS225	Fasteners, Flat Head,5/16-18 X 2-1/4", Grade 8
312CFS250	Fasteners, Flat Head,5/16-18 X 2-1/2", Grade 8
312CFS275	Fasteners, Flat Head,5/16-18 X 2-3/4", Grade 8
312CFS300	Fasteners, Flat Head,5/16-18 X 3", Grade 8
312CFS325	Fasteners, Flat Head,5/16-18 X 3-1/4", Grade 8
312CFS350	Fasteners, Flat Head,5/16-18 X 3-1/2", Grade 8
312CFS400	Fasteners, Flat Head,5/16-18 X 4", Grade 8

5/16-24 UNF

312FFS050	Fasteners, Flat Head,5/16-24 X 1/2", Grade 8
312FFS062	Fasteners, Flat Head,5/16-24 X 5/8", Grade 8
312FFS075	Fasteners, Flat Head,5/16-24 X 3/4", Grade 8
312FFS087	Fasteners, Flat Head,5/16-24 X 7/8", Grade 8
312FFS100	Fasteners, Flat Head,5/16-24 X 1", Grade 8
312FFS125	Fasteners, Flat Head,5/16-24 X 1-1/4", Grade 8
312FFS150	Fasteners, Flat Head,5/16-24 X 1-1/2", Grade 8
312FFS175	Fasteners, Flat Head,5/16-24 X 1-3/4", Grade 8
312FFS250	Fasteners, Flat Head,5/16-18 X 2-1/2", Grade 8



Hex Head



1/4-20 UNC

250CCS050-8	Cap Screw, 1/4-20 X 1/2" Grade 8
250CCS062-8	Cap Screw, 1/4-20 X 5/8" Grade 8
250CCS075-8	Cap Screw, 1/4-20 X 3/4" Grade 8
250CCS087-8	Cap Screw, 1/4-20 X 7/8" Grade 8
250CCS100-8	Cap Screw, 1/4-20 X 1" Grade 8
250CCS125-8	Cap Screw, 1/4-20 X 1-1/4" Grade 8
250CCS150-8	Cap Screw, 1/4-20 X 1-1/2" Grade 8
250CCS175-8	Cap Screw, 1/4-20 X 1-3/4" Grade 8
250CCS200-8	Cap Screw, 1/4-20 X 2" Grade 8
250CCS225-8	Cap Screw, 1/4-20 X 2-1/4" Grade 8
250CCS250-8	Cap Screw, 1/4-20 X 2-1/2" Grade 8
250CCS275-8	Cap Screw, 1/4-20 X 2-3/4" Grade 8
250CCS300-8	Cap Screw, 1/4-20 X 3" Grade 8
250CCS325-8	Cap Screw, 1/4-20 X 1/2" Grade 8

250CCS350-8	Cap Screw, 1/4-20 X 3-1/2" Grade 8
250CCS375-8	Cap Screw, 1/4-20 X 3-3/4" Grade 8
250CCS400-8	Cap Screw, 1/4-20 X 4" Grade 8
250CCS450-8	Cap Screw, 1/4-20 X 4-1/2" Grade 8
250CCS500-8	Cap Screw, 1/4-20 X 5" Grade 8

5/16-18 UNC

312CCS050-8	Cap Screw, 5/16-18 X 1/2" Grade 8
312CCS062-8	Cap Screw, 5/16-18 X 5/8" Grade 8
312CCS075-8	Cap Screw, 5/16-18 X 3/4" Grade 8
312CCS087-8	Cap Screw, 5/16-18 X 7/8" Grade 8
312CCS100-8	Cap Screw, 5/16-18 X 1" Grade 8
312CCS125-8	Cap Screw, 5/16-18 X 1-1/4" Grade 8
312CCS150-8	Cap Screw, 5/16-18 X 1-1/2" Grade 8
312CCS175-8	Cap Screw, 5/16-18 X 1-3/4" Grade 8
312CCS200-8	Cap Screw, 5/16-18 X 2" Grade 8
312CCS225-8	Cap Screw, 5/16-18 X 2-1/4" Grade 8
312CCS250-8	Cap Screw, 5/16-18 X 2-1/2" Grade 8

312CCS275-8	Cap Screw, 5/16-18 X 2-3/4" Grade 8
312CCS300-8	Cap Screw, 5/16-18 X 3" Grade 8
312CCS325-8	Cap Screw, 5/16-18 X 1/2" Grade 8
312CCS350-8	Cap Screw, 5/16-18 X 3-1/2" Grade 8
312CCS400-8	Cap Screw, 5/16-18 X 4" Grade 8
312CCS450-8	Cap Screw, 5/16-18 X 4-1/2" Grade 8
312CCS500-8	Cap Screw, 5/16-18 X 5" Grade 8
312CCS550-8	Cap Screw, 5/16-18 X 5-1/2" Grade 8
312CCS600-8	Cap Screw, 5/16-18 X 6" Grade 8
312CCS650-8	Cap Screw, 5/16-18 X 6-1/2" Grade 8

3/8-16 UNC

375CCS062-8	Cap Screw, 3/8-16 X 5/8" Grade 8
375CCS075-8	Cap Screw, 3/8-16 X 3/4" Grade 8
375CCS087-8	Cap Screw, 3/8-16 X 7/8" Grade 8
375CCS100-8	Cap Screw, 3/8-16 X 1" Grade 8
375CCS125-8	Cap Screw, 3/8-16 X 1-1/4" Grade 8
375CCS150-8	Cap Screw, 3/8-16 X 1-1/2" Grade 8
375CCS175-8	Cap Screw, 3/8-16 X 1-3/4" Grade 8
375CCS200-8	Cap Screw, 3/8-16 X 2" Grade 8
375CCS225-8	Cap Screw, 3/8-16 X 2-1/4" Grade 8
375CCS250-8	Cap Screw, 3/8-16 X 2-1/2" Grade 8
375CCS275-8	Cap Screw, 3/8-16 X 2-3/4" Grade 8
375CCS300-8	Cap Screw, 3/8-16 X 3" Grade 8

375CCS325-8	Cap Screw, 3/8-16 X 3-1/4" Grade 8
375CCS350-8	Cap Screw, 3/8-16 X 3-1/2" Grade 8
375CCS375-8	Cap Screw, 3/8-16 X 3-3/4" Grade 8
375CCS400-8	Cap Screw, 3/8-16 X 4" Grade 8
375CCS450-8	Cap Screw, 3/8-16 X 4-1/2" Grade 8
375CCS500-8	Cap Screw, 3/8-16 X 5" Grade 8
375CCS550-8	Cap Screw, 3/8-16 X 5-1/2" Grade 8
375CCS600-8	Cap Screw, 3/8-16 X 6" Grade 8
375CCS650-8	Cap Screw, 3/8-16 X 6-1/2" Grade 8
375CCS700-8	Cap Screw, 3/8-16 X 7" Grade 8

To see our full line of products,

go to kvalinc.com and type in

Hex head

Find

Hex Head



1/2-13 UNC

500CCS075	Cap Screw, 1/2-13 X 3/4" Grade 5
500CCS100	Cap Screw, 1/2-13 X 1" Grade 5
500CCS125	Cap Screw, 1/2-13 X 1-1/4" Grade 5
500CCS150	Cap Screw, 1/2-13 X 1-1/2" Grade 5
500CCS175	Cap Screw, 1/2-13 X 1-3/4" Grade 5
500CCS200	Cap Screw, 1/2-13 X 2" Grade 5
500CCS225	Cap Screw, 1/2-13 X 2-1/4" Grade 5
500CCS250	Cap Screw, 1/2-13 X 2-1/2" Grade 5
500CCS275	Cap Screw, 1/2-13 X 2-3/4" Grade 5
500CCS300	Cap Screw, 1/2-13 X 3" Grade 5
500CCS325	Cap Screw, 1/2-13 X 3-1/4" Grade 5
500CCS350	Cap Screw, 1/2-13 X 3-1/2" Grade 5
500CCS375	Cap Screw, 1/2-13 X 3-3/4" Grade 5
500CCS400	Cap Screw, 1/2-13 X 4" Grade 5

500CCS450	Cap Screw, 1/2-13 X 4-1/2" Grade 5
500CCS500	Cap Screw, 1/2-13 X 5" Grade 5
500CCS550	Cap Screw, 1/2-13 X 5-1/2" Grade 5
500CCS600	Cap Screw, 1/2-13 X 6" Grade 5
500CCS650	Cap Screw, 1/2-13 X 6-1/2" Grade 5
500CCS700	Cap Screw, 1/2-13 X 7" Grade 5
500CCS750	Cap Screw, 1/2-13 X 7-1/2" Grade 5
500CCS800	Cap Screw, 1/2-13 X 8" Grade 5

5/8-11 UNC

625CCS100	Cap Screw, 5/8-11 X 1" Grade 5
625CCS125	Cap Screw, 5/8-11 X 1-1/4" Grade 5
625CCS200	Cap Screw, 5/8-11 X 2" Grade 5
625CCS250	Cap Screw, 5/8-11 X 2-1/2" Grade 5
625CCS275	Cap Screw, 5/8-11 X 2-3/4" Grade 5
625CCS300	Cap Screw, 5/8-11 X 3" Grade 5
625CCS325	Cap Screw, 5/8-11 X 3-1/4" Grade 5
625CCS350	Cap Screw, 5/8-11 X 3-1/2" Grade 5
625CCS375	Cap Screw, 5/8-11 X 3-3/4" Grade 5
625CCS400	Cap Screw, 5/8-11 X 4" Grade 5
625CCS450	Cap Screw, 5/8-11 X 4-1/2" Grade 5

625CCS500	Cap Screw, 5/8-11 X 5" Grade 5
625CCS550	Cap Screw, 5/8-11 X 5-1/2" Grade 5
625CCS600	Cap Screw, 5/8-11 X 6" Grade 5
625CCS650	Cap Screw, 5/8-11 X 6-1/2" Grade 5
625CCS700	Cap Screw, 5/8-11 X 7" Grade 5

1/4-28 UNF

250FCS050-8	Cap Screw, 1/4-28 X 1/2" Grade 8
250FCS062-8	Cap Screw, 1/4-28 X 5/8" Grade 8
250FCS075-8	Cap Screw, 1/4-28 X 3/4" Grade 8
250FCS087-8	Cap Screw, 1/4-28 X 7/8" Grade 8
250FCS100-8	Cap Screw, 1/4-28 X 1" Grade 8
250FCS125-8	Cap Screw, 1/4-28 X 1-1/4" Grade 8
250FCS150-8	Cap Screw, 1/4-28 X 1-1/2" Grade 8
250FCS175-8	Cap Screw, 1/4-28 X 1-3/4" Grade 8
250FCS200-8	Cap Screw, 1/4-28 X 2" Grade 8
250FCS250-8	Cap Screw, 1/4-28 X 1-1/2" Grade 8
250FCS300-8	Cap Screw, 1/4-28 X 3" Grade 8
250FCS325-8	Cap Screw, 1/4-28 X 3-1/4" Grade 8

250FCS350-8	Cap Screw, 1/4-28 X 3-1/2" Grade 8
250FCS375-8	Cap Screw, 1/4-28 X 3-3/4" Grade 8
250FCS400-8	Cap Screw, 1/4-28 X 4" Grade 8
250FCS450-8	Cap Screw, 1/4-28 X 4-1/2" Grade 8
250FCS500-8	Cap Screw, 1/4-28 X 5" Grade 8
250FCS550-8	Cap Screw, 1/4-28 X 5-1/2" Grade 8





Hex Head



5/16-24 UNF

312FCS050-8	Cap Screw,5/16-24 X 1/2" Grade 8
312FCS062-8	Cap Screw,5/16-24 X 5/8" Grade 8
312FCS075-8	Cap Screw,5/16-24 X 3/4" Grade 8
312FCS087-8	Cap Screw,5/16-24 X 7/8" Grade 8
312FCS100-8	Cap Screw,5/16-24 X 1" Grade 8
312FCS125-8	Cap Screw,5/16-24 X 1-1/4" Grade 8
312FCS150-8	Cap Screw,5/16-24 X 1-1/2" Grade 8
312FCS175-8	Cap Screw,5/16-24 X 1-3/4" Grade 8
312FCS200-8	Cap Screw,5/16-24 X 2" Grade 8
312FCS225-8	Cap Screw,5/16-24 X 2-1/4" Grade 8
312FCS250-8	Cap Screw,5/16-24 X 2-1/2" Grade 8
312FCS275-8	Cap Screw,5/16-24 X 2-3/4" Grade 8
312FCS300-8	Cap Screw,5/16-24 X 3" Grade 8
312FCS325-8	Cap Screw,5/16-24 X 3-1/4" Grade 8
312FCS400-8	Cap Screw,5/16-24 X 4" Grade 8

3/8-24 UNF

375FCS062	Cap Screw,3/8-24 X 5/8" Grade 5
375FCS075	Cap Screw,3/8-24 X 3/4" Grade 5
375FCS100	Cap Screw,3/8-24 X 1" Grade 5
375FCS125	Cap Screw,3/8-24 X 1-1/4" Grade 5
375FCS150	Cap Screw,3/8-24 X 1-1/2" Grade 5
375FCS175	Cap Screw,3/8-24 X 1-3/4" Grade 5
375FCS200	Cap Screw,3/8-24 X 2" Grade 5
375FCS225	Cap Screw,3/8-24 X 2-1/4" Grade 5
375FCS300	Cap Screw,3/8-24 X 3" Grade 5

Lock Washer



WASHL006	Lock Washer, #6
WASHL008	Lock Washer, #8
WASHL010	Lock Washer, #10
WASHL250	Lock Washer, 1/4"
WASHL312	Lock Washer, 5/16"
WASHL375	Lock Washer, 3/8"
WASHL437	Lock Washer, 7/16"
WASHL500	Lock Washer, 1/2"
WASHL625	Lock Washer, 5/8"

To see our full line of products,

go to kvalinc.com and type in

Hex head

Find

Flat Washer

WASHF006	Flat Washer, #6
WASHF008	Flat Washer, #8
WASHF010	Flat Washer, #10
WASHF250	Flat Washer, 1/4"
WASHF312	Flat Washer, 5/16"
WASHF375	Flat Washer, 3/8"
WASHF437	Flat Washer, 7/16"
WASHF500	Flat Washer, 1/2"
WASHF625	Flat Washer, 5/8"

Hardened Spacer Washer

WSHR1416-.375	Washer, 1/4"-ID 7/16"-OD 1/16" Thick
WSHR1432-.375	Washer, 1/4"-ID 7/16"-OD 1/32" Thick
WSHR1464-.375	Washer, 1/4"-ID 7-16" OD 1/64" Thick

Finish Nuts—National Course

NUTC250	Finish Nut, 1/4-20
NUTC312	Finish Nut, 5/16-18
NUTC375	Finish Nut, 3/8-16
NUTC437	Finish Nut, 7/16-14
NUTC500	Finish Nut, 1/2-13
NUTC625	Finish Nut, 5/8-11
NUTC750	Finish Nut, 3/4-10

Finish Nuts—National Fine

NUTF063	Finish Nut, 6-32
NUTF083	Finish Nut, 8-32
NUTF103	Finish Nut, 10-32
NUTF250	Finish Nut, 1/4-28
NUTF375	Finish Nut, 3/8-24
NUTF437	Finish Nut, 7/16-20
NUTF500	Finish Nut, 1/2-20
NUTF625	Finish Nut, 5/8-18

Jamb Nuts—National Fine

NUTCJ250	Finish Nut, 1/4-28
NUTCJ312	Finish Nut, 5/16-24
NUTCJ375	Finish Nut, 3/8-24
NUTCJ437	Finish Nut, 7/16-20
NUTCJ500	Finish Nut, 1/2-20
NUTCJ625	Finish Nut, 5/8-18
NUTCJ750	Finish Nut, 3/4-16



Thrust Washer



TORTRA101	Thrust Bearing, TRA-1018, 5/8" I.D., .030-.032 Thick
TORTRA122	Thrust Bearing, TRA-1220, 3/4" I.D., .030-.032 Thick
TORTRA142	Thrust Bearing, TRA-1423, 7/8" I.D., .030-.032 Thick
TORTRA162	Thrust Bearing, TRA-1625, 1" I.D., .030-.032 Thick
TORTRA203	Thrust Bearing, TRA-2031, 1-1/4" I.D., .030-.032 Thick
TORTRA223	Thrust Bearing, TRA-2233, 1-3/8" I.D., .030-.032 Thick
TORTRA324	Thrust Bearing, TRA-3244, 2" I.D., .030-.032 Thick
TORTRA364	Thrust Bearing, NTA-3648, 2-1/4" I.D., .030-.032 Thick
TORTRA405	Thrust Bearing, NTA-4052, 2-1/2" I.D., .030-.032 Thick
TORTRA411	Thrust Bearing, NTA-411, 1/4" I.D., .030-.032 Thick
TORTRA512	Thrust Bearing, NTA-512, 3/8" I.D., .030-.032 Thick

TORTRA613	Thrust Bearing, NTA-613, 3/8" I.D., .030-.032 Thick
TORTRA815	Thrust Bearing, NTA-815, 1/2" I.D., .030-.032 Thick

TORTRB101	Thrust Bearing, TRB-1018, 5/8" I.D., .060-.063 Thick
TORTRB122	Thrust Bearing, TRB-1220, 3/4" I.D., .060-.063 Thick
TORTRB142	Thrust Bearing, TRB-1423, 7/8" I.D., .060-.063 Thick
TORTRB162	Thrust Bearing, TRB-1625, 1" I.D., .060-.063 Thick
TORTRB203	Thrust Bearing, TRB-2031, 1-1/4" I.D., .060-.063 Thick
TORTRB243	Thrust Bearing, TRB-2435, 1-3/8" I.D., .060-.063 Thick
TORTRB411	Thrust Bearing, TRB-411, 1/4" I.D., .060-.063 Thick
TORTRB512	Thrust Bearing, TRB-512, 3/8" I.D., .060-.063 Thick

TORTRB613	Thrust Bearing, TRB-613, 3/8" I.D., .060-.063 Thick
TORTRB815	Thrust Bearing, TRB-815, 1/2" I.D., .060-.063 Thick

TORTRC101	Thrust Bearing, TRC-1018, 5/8" I.D., .092-.095 Thick
TORTRC122	Thrust Bearing, TRC-1220, 3/4" I.D., .092-.095 Thick
TORTRC162	Thrust Bearing, TRC-1625, 1" I.D., .092-.095 Thick
TORTRC203	Thrust Bearing, TRC-2031, 1-1/4" I.D., .092-.095 Thick
TORTRC243	Thrust Bearing, TRC-2435, 1-3/8" I.D., .092-.095 Thick
TORTRC324	Thrust Bearing, TRC-3244, 2" I.D., .092-.095 Thick
TORTRC344	Thrust Bearing, TRC-3446, 2-1/4" I.D., .092-.095 Thick
TORTRC613	Thrust Bearing, TRC-1018, 3/8" I.D., .092-.095 Thick
TORTRC815	Thrust Bearing, TRC-815, 1/2" I.D., .092-.095 Thick

TORTRD122	Thrust Bearing, TRD-1220, 3/4" I.D., .123-.126 Thick
TORTRD203	Thrust Bearing, TRD-2031, 1-1/4" I.D., .123-.126 Thick
TORTRD324	Thrust Bearing, TRD-3244, 2" I.D., .123-.126 Thick



Thrust Washers continued



TORNTA101	Thrust Bearing, NTA-1018, 5/8" I.D. X 1-1/8" O.D.
TORNTA122	Thrust Bearing, NTA-1220, 3/4" I.D. X 1-1/4" O.D.
TORNTA142	Thrust Bearing, NTA-1423, 7/8" I.D. X 1-7/16" O.D.
TORNTA162	Thrust Bearing, NTA-1625, 1" I.D. X 1-9/16" O.D.
TORNTA203	Thrust Bearing, NTA-2031, 1-1/4" I.D. X 1-15/16" O.D.
TORNTA243	Thrust Bearing, NTA-2435, 1-1/2" I.D. X 2-3/16" O.D.
TORNTA324	Thrust Bearing, NTA-3244, 2" I.D. X 2-3/4" O.D.
TORNTA364	Thrust Bearing, NTA-3648, 2-1/4" I.D. X 3" O.D.
TORNTA405	Thrust Bearing, NTA-4052, 2-1/2" I.D. X 3-1/4" O.D.
TORNTA512	Thrust Bearing, NTA-512, 5/16" I.D. X 3/4" O.D.
TORNTA613	Thrust Bearing, NTA-613, 3/8" I.D. X 13/16" O.D.

Shoulder Bolt



5/16"

312SB025	Shoulder Bolt, 5/16" X 1/4", 1/4-20 Thread
312SB037	Shoulder Bolt, 5/16" X 3/8", 1/4-20 Thread
312SB050	Shoulder Bolt, 5/16" X 1/2", 1/4-20 Thread
312SB062	Shoulder Bolt, 5/16" X 5/8", 1/4-20 Thread
312SB075	Shoulder Bolt, 5/16" X 3/4", 1/4-20 Thread
312SB100	Shoulder Bolt, 5/16" X 1", 1/4-20 Thread
312SB125	Shoulder Bolt, 5/16" X 1-1/4", 1/4-20 Thread
312SB150	Shoulder Bolt, 5/16" X 1-1/2", 1/4-20 Thread

312SB175	Shoulder Bolt, 5/16" X 1-3/4", 1/4-20 Thread
312SB200	Shoulder Bolt, 5/16" X 2", 1/4-20 Thread

3/8"

375SB037	Shoulder Bolt, 3/8" X 3/8", 5/16-18 Thread
375SB050	Shoulder Bolt, 3/8" X 1/2", 5/16-18 Thread
375SB062	Shoulder Bolt, 3/8" X 5/8", 5/16-18 Thread
375SB075	Shoulder Bolt, 3/8" X 3/4", 5/16-18 Thread
375SB087	Shoulder Bolt, 3/8" X 7/8", 5/16-18 Thread
375SB100	Shoulder Bolt, 3/8" X 1", 5/16-18 Thread
375SB125	Shoulder Bolt, 3/8" X 1-1/4", 5/16-18 Thread
375SB137	Shoulder Bolt, 3/8" X 1-3/8", 5/16-18 Thread

375SB150	Shoulder Bolt, 3/8" X 1-1/2", 5/16-18 Thread
375SB175	Shoulder Bolt, 3/8" X 1-3/4", 5/16-18 Thread
375SB200	Shoulder Bolt, 3/8" X 2", 5/16-18 Thread
375SB225	Shoulder Bolt, 3/8" X 2-1/4", 5/16-18 Thread
375SB300	Shoulder Bolt, 3/8" X 3", 5/16-18 Thread
375SB325	Shoulder Bolt, 3/8" X 3-1/4", 5/16-18 Thread
375SB350	Shoulder Bolt, 3/8" X 3-1/2", 5/16-18 Thread
375SB375	Shoulder Bolt, 3/8" X 3-3/4", 5/16-18 Thread
375SB400	Shoulder Bolt, 3/8" X 4", 5/16-18 Thread

To see our full line of products,

go to kvalinc.com and type

Shoulder bolt

Find



1/2"

500SB037	Shoulder Bolt, 1/2" X 3/8", 3/8-16 Thread
500SB050	Shoulder Bolt, 1/2" X 1/2", 3/8-16 Thread
500SB062	Shoulder Bolt, 1/2" X 5/8", 3/8-16 Thread
500SB075	Shoulder Bolt, 1/2" X 3/4", 3/8-16 Thread
500SB100	Shoulder Bolt, 1/2" X 1", 3/8-16 Thread
500SB125	Shoulder Bolt, 1/2" X 1-1/4", 3/8-16 Thread
500SB137	Shoulder Bolt, 1/2" X 1-3/8", 3/8-16 Thread
500SB150	Shoulder Bolt, 1/2" X 1-1/2", 3/8-16 Thread
500SB175	Shoulder Bolt, 1/2" X 1-3/4", 3/8-16 Thread

500SB200	Shoulder Bolt, 1/2" X 2", 3/8-16 Thread
500SB225	Shoulder Bolt, 1/2" X 2-1/4", 3/8-16 Thread
500SB250	Shoulder Bolt, 1/2" X 2-1/2", 3/8-16 Thread
500SB275	Shoulder Bolt, 1/2" X 2-3/4", 3/8-16 Thread
500SB300	Shoulder Bolt, 1/2" X 3", 3/8-16 Thread
500SB375	Shoulder Bolt, 1/2" X 3-3/4", 3/8-16 Thread
500SB400	Shoulder Bolt, 1/2" X 4", 3/8-16 Thread
500SB425	Shoulder Bolt, 1/2" X 4-1/4", 3/8-16 Thread
500SB450	Shoulder Bolt, 1/2" X 4-1/2", 3/8-16 Thread

Retaining Ring



RWGN5237	Retaining Ring, Internal, 1300-237
----------	------------------------------------

Roll Pin



156RP062	Roll Pin, 5/32 X 5/8
156RP075SSD	Roll Pin, SS 5/32 X 3/4 (Coiled) Special for 6 & 8 Shooter Gearbox
156RP087SSD	Roll Pin, SS 5/32 X 7/8 (Coiled) Special for 6 & 8 Shooter Gearbox
187RP075	Roll Pin, 3/16 X 3/4
250RP225-SS	Roll Pin, Stainless Steel, 1/4" X 2-1/4" Long
MC95755A423	Roll Pin, Coiled Extra Strength Steel, 1/4" X 2" Long (700-C)



Ball Screw Nuts & Sleeves

20MM & 40MM Ball Nuts Require a Sleeve for Install. 407C or 411C



Mfg, 20mm Ball Screw Sleeve,
FMS, 3/4" Dia. X 3-19/32" Lg.

KVAL P/N: 407C



Mfg, 40mm Ball Screw Sleeve,
FMS, 1-3/8" dia. X 3-1/2" Lg.

KVAL P/N: 411C



Flange Ball Screw Nut, 20mm
Dia., 5mm Lead

KVAL P/N: BSNUT20A



Adjustable Ball screw Nut, 20mm
Dia., 5mm Lead, 1512-1-1014

KVAL P/N: BSNUT20B



Flange Ball Screw Nut, 32mm
Dia., 5mm Lead

KVAL P/N: BSNUT32A

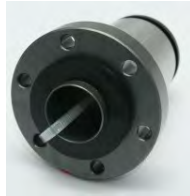

Flange Ball Screw Nut, 32mm
Dia., 10mm Lead

KVAL P/N: BSNUT32AO



Flange Ball Screw Nut, 32mm
Dia., 20mm Lead, 1512-3-7013

KVAL P/N: BSNUT32AX



Ball Screw Nut, 32mm Dia., Ad-
justable, 5mm Lead, 1512-3-1014

KVAL P/N: BSNUT32BC



Ball Screw Nut, 32mm Dia. Adjusta-
ble, 5mm Lead, 1552-3-1004

KVAL P/N: BSNUT32BLH



Ball Screw Nut, 32mm Dia., Ad-
justable, 10mm Lead, 1512-3-
4014

KVAL P/N: BSNUT32BO



Flange Ball Screw Nut, 40mm
Dia., Adjustable, 20mm Lead.

KVAL P/N: BSNUT40B



Ball Screw Nut, 50mm Dia., Ad-
justable, 5mm Lead, 1552-5-1014

KVAL P/N: BSNUT50B



Ball Screw Nut, 50mm Dia., Ad-
justable, 10mm Lead, 1512-5-
4014

KVAL P/N: BSNUT50C

To see our full line of products,

go to kvalinc.com and type

Flange bearing

Find



Flange Block Bearing



Bearing, FB 160 X 1/2", 2 Square Hole Mount, Setscrew Locking Relube

KVAL P/N: HUBFB1600



Bearing, FB 160 X 5/8", 2 Square Hole Mount, Setscrew Locking Relube

KVAL P/N: HUBFB1601



Bearing, FB 160 X 3/4", 2 Hole Mount, Setscrew Locking Relube

KVAL P/N: HUBFB1602



Bearing, FB 160 X 1", 2 Hole Mount, Setscrew Locking Relube

KVAL P/N: HUBFB1603



Bearing, FB 160 X 1-1/4", 2 Square Hole Mount, Setscrew Locking Relube

KVAL P/N: HUBFB1607



Bearing, FB 160 X 1-1/4", Short Base, 2 Square Hole Mount, Setscrew Locking Relube.

KVAL P/N: HUBFB1607-S



Bearing, FB 230 X 3/4", 2 Hole Mount, Eccentric Locking Collar Relube.

KVAL P/N: HUBFB2302



Bearing, FB 230 X 1", 2 Hole Mount, Eccentric Locking Collar Relube.

KVAL P/N: HUBFB2303



Bearing, FB 230 X 1-1/4", 2 Hole Mount, Eccentric Locking Collar Relube.

KVAL P/N: HUBFB2306



Bearing, FB 230 X 1-1/2", 2 Hole Mount, Eccentric Locking Collar Relube.

KVAL P/N: HUBFB2309



Bearing, FB 250 X 3/4", 4 Hole Mount, Setscrew Locking Relube.

KVAL P/N: HUBFB2502



Bearing, FB 250 X 1", 4 Hole Mount, Setscrew Locking Relube.

KVAL P/N: HUBFB2503



Bearing, FB 250 X 1-1/4", 4 Hole Mount, Setscrew Locking Relube.

KVAL P/N: HUBFB2506

To see our full line of products,

go to kvalinc.com and type

Pillow Blocks

Find

Pillow Blocks



Bearing, PB 220 X 1", Pillow Block, Eccentric Locking Collar Relube.

KVAL P/N: **HUBPB2203**



Bearing, Pillow Block, PB 220 X 1-1/2", Eccentric Locking Collar Relube

KVAL P/N: **HUBPB2209**



Bearing, Pillow Block, PB 250 X 3/4, Setscrew Locking Relube

KVAL P/N: **HUBPB2502**



Bearing, Pillow Block, PB 250 X 1, Setscrew Locking Relube.

KVAL P/N: **HUBPB2503**



Bearing, Pillow Block, PB 250 X 1-1/4, Setscrew Locking Relube

KVAL P/N: **HUBPB2506**



Bearing, Pillow Block, PB 250 X 1-1/2, Setscrew Locking Relube

KVAL P/N: **HUBPB2509**



Bearing, Pillow Block, TPB 250 X 3/4, Tapped Base Setscrew Locking Relube.

KVAL P/N: **HUBTPB252**



Bearing, Pillow Block, TPB 250 X 1, Tapped Base Setscrew Locking Relube.

KVAL P/N: **HUBTPB253**



Bearing, Pillow Block, TPB 250 X 1-1/4, Tapped Base Setscrew Locking Relube.

KVAL P/N: **HUBTPB256**



Bearing, Pillow Block, TPB 250 X 1-1/2, Tapped Base Setscrew Locking Relube.

KVAL P/N: **HUBTPB259**

Flange Block Bearing



Bearing, FB 260 X 3/4", 2 Hole Mount, Setscrew Locking Relube.

KVAL P/N: **HUBFB2602**



Bearing, FB 260 X 1", 2 Hole Mount, Setscrew Locking Relube.

KVAL P/N: **HUBFB2603**



Bearing, FB 260 X 1-1/4", 2 Hole Mount, Setscrew Locking Relube

KVAL P/N: **HUBFB2606**



Bearing, FB 260 X 1-1/2", 2 Hole Mount, Setscrew Locking Relube

KVAL P/N: **HUBFB2607**

To see our full line of products,

go to kvalinc.com and type

Ball Bearing

Find



Flanged Ball Bearings



Flanged Wheel Bearing, Regular Duty, 3/8" ID X 1-1/8" OD, Flange Width 7/16", Flange OD 1-1/4"

KVAL P/N: **BAI150003**



Flanged Wheel Bearing, Regular Duty, 1/2 ID - 1 3/8 OD, Flange Width 7/16, Flange OD 1-1/2.

KVAL P/N: **BAI150050**



Flanged Ball Bearing F-165 7/8 OD, 5/16 Bore, Style 47.

KVAL P/N: **KILF16500**



Flange Ball Screw Nut, 20mm Dia., 5mm Lead

KVAL P/N: **BAI150075**



Bearing 3937 Beveled with 2 Shields

KVAL P/N: **MRC200S01**



Bearing, 204FFS, .7874, 2 Felt Seals

KVAL P/N: **MRC204FFS**



Bearing 5200SBKFF, .3937 Double Row with 2 Shields

KVAL P/N: **MRC520001**



Bearing 5203ZZ, 17mm Bore, 40mm OD X 17.5 Width

KVAL P/N: **SNR5203ZZ**



Flanged Wheel Bearing, Regular Duty, 1/2 ID - 1 3/8 OD, Flange Width 7/16, Flange OD 1-1/2.

KVAL P/N: **BAI150050**



Flanged Wheel Bearing, Regular Duty, 1/2 ID - 1 3/8 OD, Flange Width 7/16, Flange OD 1-1/2. Includes Spacer and Two Bearings

KVAL P/N: **BAI150050-A**



Radial Ball Bearing



Ball Bearing, E3, 5/8, IND D3 Ball Thrust Bearing

KVAL P/N: AETE03



Ball Bearing, E5, 3/4, IND D5, Ball Thrust Bearing

KVAL P/N: AETE05



Ball Bearing, E13, 1-3/4, Ball Thrust Bearing

KVAL P/N: AETE13



Radial Ball Bearing, 204SZZ, 7874 O.D., 2 Seals

KVAL P/N: MRC204SZZ



Radial Ball Bearing, 206FSF, 1.1811 O.D., Felt Seal & Shield

KVAL P/N: MRC206FSF



Ball Bearing, 5201ZZ, .4724 5201-2NS

KVAL P/N: NAC5201ZZ



Bearing, 6200ZZ, .3937 O.D.

KVAL P/N: NAC6200ZZ



Bearing, 6202-2NSL, .5906 O.D., 1L049 NTN

KVAL P/N: NAC620201



Ball Bearing, 6203-2NSL, .6693

KVAL P/N: NAC620301



Bearing, Deep Groove, 30mm ID x 62mm OD, 2 Contact Seals, 6206-2NSE, Nachi

KVAL P/N: NAC62062NSE



Bearing, 6208-2NSE, 1.5748 I.D, 3.150 O.D.

KVAL P/N: NAC620801



Radial Ball Bearing, 77R8, 1/2" Bore

KVAL P/N: NAC77R08



Radial Ball Bearing, 77R10, 5/8" Bore

KVAL P/N: NAC77R10



Radial Ball Bearing, 77R12, 3/4" Bore

KVAL P/N: NAC77R12



Radial Ball Bearing, 77R16, 1" Bore

KVAL P/N: NAC77R16



Radial Ball Bearing, R6, 3/8" Bore

KVAL P/N: PAC77R06

To see our full line of products,

go to kvalinc.com and type

Pillow block

Find



Open Pillow Block



Bearing, Linear, 3/4 Super Open, With Seals, Single Row Bearings

KVAL P/N: **INAKNZ12PP**



Bearing, 3/4" Open Super Linear Pillow Block, Single Row

KVAL P/N: **INASPBI20-S**



Bearing, 1" Open Super Linear Pillow Block

KVAL P/N: **INASPB160**



Bearing, 1-1/2" Open Super Linear Pillow Block

KVAL P/N: **INASP240**



Bearing, SPB-24-OPN Open PB, 1-1/2" Super Linear Bearing Block With Steel Bearing

KVAL P/N: **THOSPB240-ABB**



Bearing, SPB-32-OPN Open PB, 2" Super Linear Bearing Block With Steel Bearing

KVAL P/N: **THOSPB320-ABB**



3/4 Super Open Linear Bearing With Seals, Single Row Bearings NB (Does Not Include Housing)

KVAL P/N: **BRG-NB12-0PN**



1-1/2 Super Open Linear Bearing With Seals, Single Row Bearings NB, (Does Not Include Housing)

KVAL P/N: **BRG-NB24-0PN**

Closed Pillow Blocks



Bearing, KX12PP 3/4" Closed, Bearing Only

KVAL P/N: **INAKX12PP**



Bearing, 3/4" Closed Super Linear Pillow Block

KVAL P/N: **INASPBC120**



Bearing, 1" Closed Super Linear Pillow Block

KVAL P/N: **INASPBC160**

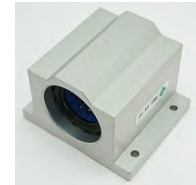

Bearing, 1-1/2" Closed Super Linear Pillow Block

KVAL P/N: **INASPBC240**



Bearing, Modified 1-1/2" Closed Super Linear Pillow Block

KVAL P/N: **INASPBC240M1**



Bearing, Super 16, 1" Closed Linear Ball Bearing

KVAL P/N: **THOLBB16**



Bearing, 3/4" Closed Linear Ball Bearing (Not Self Aligning, Does Not Include Housing) (NBSW12)

KVAL P/N: **BRG-NB12-CL-STEEL**





KVAL Anodized Bearing Blocks



Linear Bearing Block, With Standard 3/4 Bearing & 2 Seals, 2" Long, 1-1/2 Square

KVAL P/N: KVALBB12A



Linear Bearing Block, With Standard 1 Bearing & 2 Seals 2-3/4 Long 2 Square.

KVAL P/N: KVALBB16A

Spherical Bearing



Bearing, Fafnir G1012KRRB, 3/4 I.D., AG Wide Inner Ring Ball Bearing Insert With Eccentric Lock

KVAL P/N: FAFG1012

Linear Bearings



Ball Rail Bearing, 15mm Bearing Assembly with seals, INA

KVAL P/N: BR15MMB-A



Ball Rail Bearing, 25mm Bearing Assembly with seals, INA

KVAL P/N: BR25MMB-A



Seals, 15mm Runner Block, 2 Piece Front Seals, 1619-121-20

KVAL P/N: STA161912120



Seals, 25mm Runner Block, 2 Piece Front Seals, 1619-221-30

KVAL P/N: STA161922130



Generation 2 15MM Star Ball Rail Bearings STA165111420 W/2 161912120 Seals Installed
Substitute for: NAC620201

KVAL P/N: STA165111420S



Generation 2 25MM Star Ball Rail Bearing STA165121420 W/2 161922130 Seals Installed
Substitute for: NAC620301

KVAL P/N: STA165121420S



Generation 2 35MM Star Ball Rail Bearing STA165131420 W/2 161932130 Seals Installed

KVAL P/N: STA165131420S

Grease Fittings



Grease Fitting, 1/4-28 Straight Taper Thread

KVAL P/N: ZIRK-FITTINGS



45 Degree Angle Grease Fitting, 1/4-28 Straight Taper Thread

KVAL P/N: ZIRK-FITTING1



90 Degree Angle Grease Fitting, 1/4-28 Straight Taper Thread

KVAL P/N: ZIRK-FITTING2



10-32 Thread Grease Fitting, Straight Thread Special

KVAL P/N: ZIRK-FITTING6



Taper Roller Bearings



Timken Bearing For Ball Screw Housing (32MM)

KVAL P/N: **TIM15106**



Timken Bearing Cup For Ball Screw Housing, 32MM Screw

KVAL P/N: **TIM15243**



Tapered Roller Bearing Race, Timken # 28622, 32mm For Spinning Ball Nut Assy

KVAL P/N: **TIM28622**



Tapered Roller Bearing, Timken # 28682, 32mm For Spinning Ball Nut Assy

KVAL P/N: **TIM28682**



Tapered Roller Bearing Race, Single Row Use with Tapered Roller Bearing TIM28985

KVAL P/N: **TIM28921**



Tapered Roller Bearing, Single Row Use with Roller Bearing Race TIM28921

KVAL P/N: **TIM28985**



Timken Bearing Race For the ball screw Housing (20MM)

KVAL P/N: **TIMLM11710**



Timken Bearing Race For the ball screw Housing (20MM)

KVAL P/N: **TIMLM11749**



Breco Self Tracking



Belt, Breco Flex, 50mm, 10 Pitch, 840mm long

KVAL P/N: **BRE50AT10-840BFX**



Belt, Breco Self Tracking Belt, 50.8 HK/1854.2 V

KVAL P/N: **BREBELT073**



Belt, Breco Self Tracking Belt, 50.8 HK/3479.8 V

KVAL P/N: **BREBELT137**



Belt, Breco Self Tracking Belt, 50.8 HK/5321.3 V

KVAL P/N: **BREBELT209.5**



Gearbelt



Belt, Gearbelt, 1" Wide, 220
Teeth, 1100H100

KVAL P/N: **BLT110H10**



Belt, Gearbelt, 3/4" Wide, 33
Teeth, 3/8 Pitch Timing Belt,
124L075

KVAL P/N: **BLT124L75**



Belt, Gearbelt, 1" Wide, 40 Teeth,
150L100

KVAL P/N: **BLT135L75**



Tapered Roller Bearing, Timken #
28682, 32mm For Spinning Ball
Nut Assy

KVAL P/N: **BLT150L10**



Belt, Gearbelt, 1" Wide, 44 Teeth,
165L100

KVAL P/N: **BLT165L10**



Belt, Gearbelt, 1" Wide, 46 Teeth,
172L100

KVAL P/N: **BLT172L10**



Belt, Gearbelt, 1" Wide, 50 Teeth,
187L100

KVAL P/N: **BLT187L10**



Belt, Gearbelt, 3/4" Wide, 50
Teeth, 187L075

KVAL P/N: **BLT187L75**



Belt, Gearbelt, 1" Wide, 52 Teeth,
195L100

KVAL P/N: **BLT195L10**



Belt, Gearbelt, 1" Wide, 42 Teeth,
210H100

KVAL P/N: **BLT210H10**



Belt, Gearbelt, 1" Wide, 56 Teeth,
210L100

KVAL P/N: **BLT210L10**



Belt, Gearbelt, 1/2" Wide, 56
Teeth, 210L050

KVAL P/N: **BLT210L50**



Belt, Gearbelt, 3/4" Wide, 56
Teeth, 210L075

KVAL P/N: **BLT210L75**



Belt, Gearbelt, 1" Wide, 220H100

KVAL P/N: **BLT220H10**



Belt, Gearbelt, 1" Wide, 60 Teeth,
225L100

KVAL P/N: **BLT225L10**



Belt, Gearbelt, 3/4" Wide, 60
Teeth, 225L075

KVAL P/N: **BLT225L75**

To see our full line of products,

go to kvalinc.com and type

belts

Find



Belt, Gearbelt, 1" Wide, 46 Teeth, 230H100

KVAL P/N: **BLT230H10**



Belt, Gearbelt, 1" Wide, 48 Teeth, 240H100

KVAL P/N: **BLT240H10**



Belt, Gearbelt, 3/4" Wide, 64 Teeth, 240L075

KVAL P/N: **BLT240L75**



Belt, Gearbelt, 1" Wide, 68 Teeth, 255L100

KVAL P/N: **BLT255L10**



Belt, Gearbelt, 1" Wide, 54 Teeth, 270H100

KVAL P/N: **BLT270H10**



Belt, Gearbelt, 1-1/2" Wide, 54 Teeth, 270H150

KVAL P/N: **BLT270H150**



Belt, Gearbelt, 1" Wide, 72 Teeth, 270L100

KVAL P/N: **BLT270L10**



Belt, Gearbelt, 3/4" Wide, 72 Teeth, 270L075

KVAL P/N: **BLT270L75**



Belt, Gearbelt, 1" Wide, 60 Teeth, 300H100

KVAL P/N: **BLT300H10**



Belt, Gearbelt, 1" Wide, 80 Teeth, 300L100

KVAL P/N: **BLT300L10**



Belt, Gearbelt, 3/4" Wide, 80 Teeth, 300L075, 18.75" Long

KVAL P/N: **BLT300L75**



Belt, Gearbelt, 1" Wide, 60 Teeth, 320H100

KVAL P/N: **BLT320H10**



Belt, Gearbelt, 3/4" Wide, 86 Teeth, 322L075

KVAL P/N: **BLT322L75**



Belt, Gearbelt, 1" Wide, 60 Teeth, 330H100

KVAL P/N: **BLT330H10**



Belt, Gearbelt, 1" Wide, 72 Teeth, 360H100

KVAL P/N: **BLT360H10**



Belt, Gearbelt, 1" Wide, 78 Teeth, 390H100

KVAL P/N: **BLT390H10**



Belt, Gearbelt, 3/4" Wide, 104 Teeth, 390L075

KVAL P/N: **BLT390L75**



Belt, Gearbelt, 1" Wide, 84 Teeth, 420H100

KVAL P/N: **BLT420H10**



Belt, Gearbelt, 3/4" Wide, 84 Teeth, 420L075

KVAL P/N: **BLT420L75**



Belt, Gearbelt, 1" Wide, 90 Teeth, 450H100

KVAL P/N: **BLT450H10**





Gearbelt



Belt, Gearbelt, 1" Wide, 120
Teeth, 3/8 Pitch Timing, 450L100

KVAL P/N: **BLT450L10**



Belt, Gearbelt, 1" Wide, 510L100

KVAL P/N: **BLT510L10**



Belt, Gearbelt, 1" Wide, 120
Teeth, 600H100

KVAL P/N: **BLT600H10**



Belt, Gearbelt, 1" Wide, 126
Teeth, 630H100

KVAL P/N: **BLT630H10**



Belt, Gearbelt, 1" Wide, 132
Teeth, 660H100

KVAL P/N: **BLT660H10**



Belt, Gearbelt, 1" Wide, 140 Teeth,
700H100

KVAL P/N: **BLT700H10**



Belt, Gearbelt, 1" Wide, 170
Teeth, 850H100

KVAL P/N: **BLT850H10**

Grip Notch



Belt, Gripnotch, 25 Outside
Length

KVAL P/N: **BLT3VX250**



Gripbelt A31 33.2" Outside Length

KVAL P/N: **BLTA031**



Gripbelt A32 34" Outside Length,
4L340

KVAL P/N: **BLTA032**



Gripbelt A37 39.2" Outside Length
(Fixed Side)

KVAL P/N: **BLTA037**



Gripbelt A39 41.2" Outside
Length

KVAL P/N: **BLTA039**



Gripbelt A41, 43" Outside Length

KVAL P/N: **BLTA041**



Gripbelt A53 55.2" Outside Length

KVAL P/N: **BLTA053**



Belt, BX32, Grip Notch Belt, 35
Outside Length

KVAL P/N: **BLTBX32**

To see our full line of products,

go to kvalinc.com and type

Habasit

Find



Belt, BX34, Grip Notch Belt, 37 Outside Length

KVAL P/N: **BLTBX34**



Belt, BX36, Grip Notch Belt, 39 Outside Length

KVAL P/N: **BLTBX36**

Habasit Belts



Belt, Habasit, 3/4 X 20' Long.

KVAL P/N: **HAB1220**



Belt Green Polycord Habasit 1/4 RD (R7) (Qty and Price Per Ft)

KVAL P/N: **HABP0100**



Belt Green Polycord, 34-1/2" LG, 1/4 RD

KVAL P/N: **HABP3408**

Orange V-Belting



Flat Top Orange V-Belting 5/8 Top Width B Section (Quantity/ Price Per Foot)

KVAL P/N: **VBELTFT10**



Belt, Flat Top Orange V-Belting 5/8 Top Width Back Section , 294" Long

KVAL P/N: **VBELTFT10294**



Belt, Flat Top Orange V-Belting 5/8 Top Width Back Section, 100 Foot Box

KVAL P/N: **VBELTFT10BOX**



Wing Top Orange V-Belting 5/8 Top Width B Section (Quantity/ Price Per Foot).

KVAL P/N: **VBELTWT10**



Belt, Wing Top Orange V-Belting 5/8 Top Width Front Section, 255-5/8" Long

KVAL P/N: **VBELTWT10255625**



Belt, Wing Top Orange V-Belting 5/8 Top Width Front Section, 100 Foot Box

KVAL P/N: **VBELTWT10BOX**



Orange V-Belting continued



Belting Flat Top With Nylon Cord Volta, (Qty/Price Per Foot)

KVAL P/N: **BLTKCNVOS-17**

BLTKCNVOS-114IF	Model, DL-NCB, 114" Flat Top Endless Belt with Cord, Infeed Fixed Side
BLTKCNVOS-114OF	Model, DL-NCB, 114" Flat Top Endless Belt with Cord, Outfeed Fixed Side
BLTKCNVOS-115IF	Model, DL-NCB, 115" Flat Top Endless Belt with Cord, Infeed Fixed Side
BLTKCNVOS-115OF	Model, DL-NCB, 115" Flat Top Endless Belt with Cord, Outfeed Fixed Side
BLTKCNVOS-115OM	Model, DL-NCB, 115" Flat Top Endless Belt with Cord, Outfeed Movable Side
BLTKCNVOS-116	Model, DL-NCB, 116" Flat Top Endless Belt with Cord, Infeed Movable Side
BLTKCNVOS-118IM	Model, DL-NCB, 118" Flat Top Endless Belt with Cord, Infeed Movable Side
BLTKCNVOS-118OF	Model, DL-NCB, 118" Flat Top Endless Belt with Cord, Outfeed Fixed Side
BLTKCNVOS-119	Model, DL-NCB, 119" Flat Top Endless Belt with Cord, Outfeed Movable Side
BLTKCNVOS-131	Model, DL-NCB, 131 Flat Top Endless Belt with Cord, Outfeed Fixed Side
BLTKCNVOS-134OF	Model, DL-NCB, 134" Flat Top Endless Belt with Cord, Outfeed Fixed Side
BLTKCNVOS-134OM	Model, DL-NCB, 134" Flat Top Endless Belt with Cord, Outfeed Movable Side
BLTKCNVOS-139.25	Model, DL-NCB, 139-1/4" Flat Top Endless Belt with Cord, Outfeed Movable Side
BLTKCNVOS-139.75	Model, DL-NCB, 139-3/4" Flat Top Endless Belt with Cord, Infeed & Outfeed Moveable Side
BLTKCNVOS-144	DL-NCB, 144" Flat Top Endless Belt with Cord, Infeed Fixed Side
BLTKCNVOS-144.5	DL-NCB/DL-NCC, 144-1/2" Flat Top Endless Belt with Cord, Infeed Fixed Side

BLTKCNVOS-145.25	DL-NCB/DL-NCC, 145-1/4" Flat Top Endless Belt with Cord, Infeed/Outfeed Movable Side
BLTKCNVOS-145.5	DL-NCB, 145-1/2" Flat Top Endless Belt with Cord, Infeed Movable Side
BLTKCNVOS-148	DL-NCB, 148" Flat Top Endless Belt with Cord, Infeed Movable Side
BLTKCNVOS-182.75	Model, DL-NCC, 182-3/4" Flat Top Endless Belt with Cord, Infeed Moveable
BLTKCNVOS-183	Model, DL-NCC, 183" Flat Top Endless Belt with Cord, Infeed Fixed
BLTKCNVOS-281.5	Model, DL-NCB, 281-1/2" Flat Top Endless Belt with Cord, Infeed & Outfeed Moveable Side

Urethane Belts



Drive Belting Conveyor Urethane 3/16 Dia., Qty/Price Ft.

KVAL P/N: **BLT0300U**



Belt Urethane 3/16 Dia. X 13

KVAL P/N: **BLT0313U**



Belt Urethane 3/16 Dia. X 13 Twisted O Ring With Hook

KVAL P/N: **BLT0313U-TWISTED**

V-Belts



Belt, V-Belt, 29-1/2" Long, 5/16 Wide Rib Top

KVAL P/N: BELT7M750



V-Belt 39.37 Long 7/16 Wide Rib Top Polyflex, Gates

KVAL P/N: BLT11M1000



V-Belt 40.55 Long 7/16 Wide Rib Top Polyflex

KVAL P/N: BLT11M1030



V-Belt 41.73 Long 7/16 Wide Rib Top Polyflex

KVAL P/N: BLT11M1060



V-Belt, 31.50 Long, 7/16 Wide Rib Top Polyflex, Tool Drive Motor Belt

KVAL P/N: BLT11M800



Belt, V-Belt, 32.48 Long, 7/16 Wide Rib Top

KVAL P/N: BLT11M825



Belt, V-Belt, 33.46 Long, 7/16 Wide Rib Top

KVAL P/N: BLT11M850



Belt, V-Belt, 34.45 Long, 7/16 Wide Rib Top Polyflex

KVAL P/N: BLT11M875



Belt, V-Belt, 35.43 Long, 7/16 Wide Rib Top Polyflex

KVAL P/N: BLT11M900



V-BELT 38.39 Long, 7/16 Wide Rib Belt

KVAL P/N: BLT11M975



V-Belt, B28, 31 Outside Length, 29.8 Pitch, 5L310

KVAL P/N: BLTB28



V-Belt, B29, 32 Outside Length, 30.8 Pitch, 5L320

KVAL P/N: BLTB29



V-Belt, B30, 33 Outside Length, 34.8 Pitch, 5L330

KVAL P/N: BLTB30



V-Belt, B33, 36 Outside Length, 34.8 Pitch, 5L360

KVAL P/N: BLTB33



V-Belt, B34, 37 Outside Length, 35.8 Pitch, 5L370

KVAL P/N: BLTB34



V-Belt, B35, 38" Outside Length, 5L380

KVAL P/N: BLTB35



V-Belt, B42, 45" Outside Length, 5L450

KVAL P/N: BLTB42

Splice Kit & Gun



UT-236 Weld-Splice Kit for V-Belt Splicing

KVAL P/N: UT236000



UT-6 Soldering Gun, Fenner

KVAL P/N: UT236060



Fenner, Hot Knife Teflon Blade For UT-236 Weld Splice Kit, 5700229

KVAL P/N: UT23606D



Cutter Blade, Fenner, Replacement Blade for the UT-236 Splice Kit, UT2-1

KVAL P/N: UT236UT21

Chain



Chain, #35 Single Strand, 3/8, Qty per Foot

KVAL P/N: CHA35



Chain, #35, Cut to Size 124-1/2"

KVAL P/N: CHA35124.5



Chain, #40, Cut to Size 122"

KVAL P/N: CHA40122



Chain, #40, Cut to Size 50"

KVAL P/N: CHA4050



Chain, Connecting link, 35 Chain

KVAL P/N: LIN350001



Chain, Connecting link, 40 Chain

KVAL P/N: LIN400001



Chain, Offset Link, 40 Chain

KVAL P/N: LIN400002



Chain, Connecting Link, 50 Chain

KVAL P/N: LIN500001

To see our full line of products,

go to kvalinc.com and type

Clutch

Find



Chain, Offset Link, 50 Chain

KVAL P/N: LIN500002



Chain, Roller Link, 60 Chain

KVAL P/N: LIN600003

Clutch



CAR220002	Clutch Disc Pac MDP #22 X 1-3/16" X 3/32 Keyway, MDP002299925000
CAR230002	Clutch Disc Pac MDP #23 X 1-1/4" (1/4 X 1/8 Keyway) (777) MDP002399935000
CAR230004	Clutch Disc Pac MDP #23 X 1-3/8"



Over-Running Clutch, CR-100, 1" Bore, 1-Way

KVAL P/N: DAYCR100



Over-Running Clutch, CR-200, 1-1/2" Bore, 1-Way

KVAL P/N: DAYCR200



FMCBES Model 625 Clutch-Brake Com

KVAL P/N: HOR801623



Clutch, SO500 Sprag Clutch, 1.25 AM Bore, Sealed For Life, BSK11021

KVAL P/N: SPRBSK11021



HANDLER,100 Series Clutch Assembly for Door Clamp Vertical Movement (Includes Input & Output Shafts),(3-1/2"DIA 97")

KVAL P/N: HANDLER01



HANDLER,200 Series Clutch Assembly for Door Clamp Vertical Movement (includes Input & Output Shafts, 4-3/8" DIA & End Plate 4-1/2" LG Shafts 97+

KVAL P/N: HANDLER02



Coupler



Helical Flex Shaft Coupling, 1/2" X 3/8" X 1-1/2" LG, ACR112-16-12

KVAL P/N: ACR112-16-12



Coupler, 1" Dia. Bore Sleeve 3" Long with Keyseat, CS 16 K

KVAL P/N: BROCS16K



Coupler, Neoprene Sleeve, 3/8" to 7/8" Bore Range, 6428K55

KVAL P/N: LOV6428CPL



Coupler, Neoprene Gear and Sleeve, Zinc Alloy Hub, 3/8" to 7/8" Bore Range 3/8" to 7/8" Bore Range, 6428K45

KVAL P/N: LOV6428K4512



Coupler, 1-1/4" X 1-1/4" Bore, 2-1/16" OD, Rigid Two-Piece Clamp-on Shaft Coupling Steel With Keyway, 60845K18

KVAL P/N: MC60845K18



CPLR0420	Coupler, 1/4-20 X 1-3/4 Long, Threaded
CPLR0518	Coupler, 5/16-18 X 1-3/4 Long, Threaded
CPLR0524	Coupler, 5/16-24 X 1 Long, Threaded
CPLR0616	Coupler, 3/8-16 X 1-3/4 Long, Threaded
CPLR0720	Coupler, 7/16-20 X 1-1/4 Long, Threaded
CPLR0720175	Coupler, 7/16-20 X 1-3/4 Long, Threaded
CPLR0811	Coupler, 1/2-13 X 1-1/4 Long, Threaded



CPLR0813	Coupler, 1/2-13 X 1-3/4 Long, Threaded
CPLR0820	Coupler, 1/2-20 X 1-1/4 Long, Threaded
CPLR0820-L	Coupler, 1/2-20 X 1-3/4 Long, Threaded
CPLR1011	Coupler, 5/8-11 X 2-1/8 Long, Threaded
CPLR1210	Coupler, 3/4-10 X 2-1/4 Long, Threaded
CPLR1216	Coupler, 3/4-16 X 2-1/4 Long, Threaded
CPLR1614	Coupler, 1-14 X 2-3/4 Long, Threaded

To see our full line of products,

go to kvalinc.com and type in

Disc brake

Find

Disc Brake



Kit Includes Brake and Special Gear (Longer). Magnetic Disk Brake for 56C, 143TC, & 145TC Motors (ON-2) 3450 RPM Static Torque 6 Foot LBS. 3HP

Substitute for: [DAY3M366](#)

KVAL P/N: **DAY3M366-KIT**



Magnetic Disc Brake for C-Face Motors, Static Torque 3 Foot LBS

KVAL P/N: **DAY6K233**

Gearbelt Pulley



Gearbelt Pulley, 12LF075 X 1/2", Smooth Bore Without Keyway

KVAL P/N: **BRO12L751**



Gearbelt Pulley, 14 Groove, 2.174 O.D., 14HG100, Use G Bushing

KVAL P/N: **BRO14HG10**



Gearbelt Pulley, 14 Groove, 2.174 O.D., Use G Bushing

KVAL P/N: **BRO14HG150**



Gearbelt Pulley, 15LF075 X 5/8" With Keyway

KVAL P/N: **BRO15L753**



Gearbelt Pulley, 18HH100, 18 Groove, 2.811 OD, Use H Bushing

KVAL P/N: **BRO18HH10**



Gearbelt Pulley, 18 Groove, 2.119 O.D., 18LG100, Use G Bushing

KVAL P/N: **BRO18LG10**



Gearbelt Pulley, 18LG075, 18 Groove, Use G Bushing

KVAL P/N: **BRO18LG75**



Gearbelt Pulley, 20HH100, 20 Groove, Use H Bushing

KVAL P/N: **BRO20HH10**



Gearbelt Pulley, 20LG100, 20 Groove, 2.357 OD, Use G Bushing

KVAL P/N: **BRO20LG10**



Gearbelt Pulley, 20 Groove, 2.357 O.D., 20LG075, Use G Bushing

KVAL P/N: **BRO20LG75**



Gearbelt Pulley, 21LG100, 21 Groove, 2.477 OD, Use G Bushing

KVAL P/N: **BRO21LG10**



Gearbelt Pulley, 22 Groove, 3.447 O.D., 22HH100, Use H Bushing

KVAL P/N: **BRO22HH10**



Gearbelt Pulley, 22LG075, 22 Groove, 2.596 OD, Use G Bushing

KVAL P/N: **BRO22LG75**



Gearbelt Pulley, 28 Groove, 4.402 O.D., 28HH100, Use H Bushing

KVAL P/N: **BRO28HH10**



Gearbelt Pulley, 36 Groove, 4.267 O.D., 36LH10, Use H Bushing

KVAL P/N: **BRO36LH10**

Idler



Idler, #35 Chain, 20T X 5/8 Bore Sprocket, 35BB20H

KVAL P/N: **BROHB3503**



Idler, #40 Chain, 17T X 1/2" Bore Sprocket

KVAL P/N: **BROHB4002**



Idler, #40 Chain, 17T X 5/8" Bore Sprocket

KVAL P/N: **BROHB4003**



Idler, #50 Chain, 15T X 5/8" Bore Sprocket

KVAL P/N: **BROHB5003**

Lovejoy Couplings



LoveJoy, L075 Coupling Body, 1/2" Bore, Part of 3 Piece Flexible Coupling With 1/8" Keyway

KVAL P/N: **LOVL07508**



LoveJoy, L075 Coupling Body, 1/2" Bore, Part of 3 Piece Flexible Coupling With 3/16" Keyway

KVAL P/N: **LOVL07508B**



LoveJoy, L075 Coupling Body, 5/8" Bore, Part of 3 Piece Flexible Coupling With 1/8" Keyway

KVAL P/N: **LOVL07510**



LoveJoy, L075 Coupling Body, 5/8" Bore, Part of 3 Piece Flexible Coupling With 5/32" Keyway

KVAL P/N: **LOVL07510A**



LoveJoy, L075 Coupling Body, 5/8" Bore, Part of 3 Piece Flexible Coupling With 3/32" Keyway and (2) 1/4-20 Set screws

KVAL P/N: **LOVL07510MPD**



LoveJoy, L075 Coupling Body, 7/8" Bore, Part of 3 Piece Flexible Coupling

KVAL P/N: **LOVL07514**



LoveJoy, L090 Coupling Body, 1/2" Bore, Part of 3 Piece Flexible Coupling

KVAL P/N: **LOVL09008**



LoveJoy, L090 Coupling Body, 3/4" Bore, Part of 3 Piece Flexible Coupling

KVAL P/N: **LOVL09012**

To see our full line of products,

go to kvalinc.com and type in

Lovejoy

Find



LoveJoy, L090 Coupling Body,
7/8" Bore, Part of 3 Piece Flexible
Coupling

KVAL P/N: **LOVL09014**



LoveJoy, L090 Coupling Body, 1"
Bore, Part of 3 Piece Flexible
Coupling

KVAL P/N: **LOVL09016**



LoveJoy, L095 Coupling Body,
5/8" Bore, Part of 3 Piece Flexible
Coupling

KVAL P/N: **LOVL09510**



LoveJoy, L095 Coupling Body,
3/4" Bore, Part of 3 Piece Flexible
Coupling

KVAL P/N: **LOVL09512**



LoveJoy, L095 Coupling Body,
7/8" Bore, Part of 3 Piece Flexible
Coupling

KVAL P/N: **LOVL09514**



LoveJoy, L095 Coupling Body, 1"
Bore, Part of 3 Piece Flexible
Coupling

KVAL P/N: **LOVL09516**



LoveJoy, L095 Jaw Coupling Hub,
19MM Bore

KVAL P/N: **LOVL09519MM**



LoveJoy, L095 Coupling for Six
Shooter Flywheel
Substitute for: SS214BA2

KVAL P/N: **13-00-AP2**

Lovejoy Spider



HYTREL Spider or Connectors
For the 075 LoveJoy Series

KVAL P/N: **SPIDER004-H**



HytreL Spider or Connector for the
090 and 095 Series Flexible Cou-
plings.

KVAL P/N: **SPIDER005-H**

GearBoxes



Gearbox, 90 Degree 1:1 Ratio,
1" Bore RH Float-A-Shaft

KVAL P/N: **BRA4304-0344**



Pulley



Pulley, Drive Pulley, Aluminum
6061-T6 X 2-1/4 Dia. X 1-5/8

KVAL P/N: 590C



Pulley, Double Sheave Belt Pulley
Assembly

KVAL P/N: 603A



Pulley, Single Sheave Belt Pulley
Assembly

KVAL P/N: 604A



FACE/GATEWAY, Modified Self
Tracking Pulley, BRECLS55HK, 1"
BORE X 1/4" KW 1/4-20 SS.

KVAL P/N: BRECLS55HKM



Gearbelt Pulley, 2BK27 X 1" Bore,
Double Sheave, 2.70 O.D.

KVAL P/N: BRO2BK27



Gearbelt Pulley, 2BK67H, Double
Sheave 6.45" OD. Use H Bushing

KVAL P/N: BRO2BK67H1



Gearbelt Pulley, 2 Groove, 3.15
O.D. Sheave, Use H Bushing

KVAL P/N: BRO2H3V31



Pulley, Gearbelt, BK55H, Single
Sheave 5" OD Tapered Bore,
Modified

KVAL P/N: BROBK55HX



Pulley, BK55H Pulley Single
Sheave 5-OD 1.997 Bore with
oilite (Modified) (Auto feed). Hex
Pulley

KVAL P/N: BROBK55HY



Moveable Feed Pulley, PRE-2002
Assembly, BK55H Pulley Single
Sheave 5-OD, Round Bore W/Key
(Auto Feed)

KVAL P/N: BROBK55HY-1



Pulley, BROBK65, Modified Bore
to 1.313 +.000/-0.001 For BH1612
Needle Bearing

KVAL P/N: BROBK65M



Idler Pulley, Flat Face, 4-3/8" OD,
1" Bore, 1-1/16" Face, 2-1/8" Shaft

KVAL P/N: BRON4DIF



Arbor Pulley, DL-2 Cutter Head Assy 20-
24 Gauge Doors VER 1991 Substitute
for: DL22301.D27

KVAL P/N: DL2-26DX



Pulley, DL-2 Motor Cutter Head Assy
VER 1995 4.75 OD (3200 RPM Low-
8300 RPM High.
Substitute for: DL2-26DY

KVAL P/N: DL2301.D26



DL-2, Head, 3-Groove Arbor
Pulley, 4.1 DIA X 2 3/16

KVAL P/N: 37-00-DX1



DL-2, Head, 3-Groove Motor
Pulley, 5 DIA X 2 3/16

KVAL P/N: 37-00-DY1

Verify the Part Number Engraved on the DL-2 Pulleys

To see our full line of products,

go to kvalinc.com and type

seals

Find

Seals



Seal 3/8" I.D., .6875 O.D. Single Lip, Chicago Rawhide 3645

KVAL P/N: SEAL06A



Seal 1/2-ID .875 OD Single Lip

KVAL P/N: SEAL08



Seal 5/8" I.D., 1.124 O.D., Double Lip Spring loaded, Chicago Rawhide 6204

KVAL P/N: SEAL10A



Seal 3/4-ID 1.254-OD (S-750) Single Lip.

KVAL P/N: SEAL12



Seal, 1.25 I.D. X 1.629 O.D. X 3/16 Thick

KVAL P/N: SEAL12329



Seal 1-ID 1.567-OD Single Lip

KVAL P/N: SEAL16



Seal, 3.875" O.D. X 1.750" I.D., .313 Thick, CR17234

KVAL P/N: SEAL17234



Seal 1-1/2-ID 2.374-OD Single Lip

KVAL P/N: SEAL24



Seal, 3.876" O.D. X 3.00" I.D., .313 Thick, CR29877

KVAL P/N: SEAL29877



Seal, V-Ring Seal For Motor Shafts, Baldor 5HP Motor, 400281

KVAL P/N: SEAL400281



Seal, 1-1/4" O.D. X .750" I.D., 1/4 Wide With Brass Case & SS

KVAL P/N: SEAL7443



Seal, 1.254" O.D. X .875" I.D., Single Lip

KVAL P/N: SEAL8624



Torque Limiter



Torque Limiter, 3/4 Bore, With 40A20G Sprocket, Assembled and Burned In

KVAL P/N: DALOSD253-1A



Torque Limiter, 7/8 Bore, With 40A20G Sprocket, Assembled and Burned In

KVAL P/N: DALOSD256-1A



Torque Limiter 1 Bore with 40A26G Sprocket and Burned In.

KVAL P/N: DALOSD362-1A



Torque Limiter, 1" Bore with DAL50T35L22G Sprocket and Burned In, DALTON OSD362

KVAL P/N: DALOSD362-1B



Torque Limiter 1-3/8" Bore with 50A26G Sprocket and Burned In.

KVAL P/N: DALOSD450-1A

Speed Reducer



Speed Reducer, 920 MWN-LR, 20:1 Ratio, 86 RPM, Winsmith C-Face

KVAL P/N: WIN920MW2



Speed Reducer, 920 MWN-LR, 20:1 Ratio, 86 RPM, Winsmith C-Face, Shaft Length Modified

KVAL P/N: WIN920MW2M



Speed Reducer, 920 MWN-LR, 30:1 Ratio, 58 RPM, Winsmith C-Face

KVAL P/N: WIN920MW3



Speed Reducer, 920 MWN-LR, 40:1 Ratio, 43 RPM, Winsmith C-Face

KVAL P/N: WIN920MW4



Speed Reducer, 924 MDN, 40:1 Ratio, 56 CLR, Winsmith, C-Face

KVAL P/N: WIN924MDN



Speed Reducer, 930 MWN-LR, 30:1 Ratio, 58 RPM, Winsmith 1-3/8 Output Shaft

KVAL P/N: WIN930MW3



Speed Reducer, 930 MWN-LR, 50:1 Ratio, 35 RPM, Winsmith

KVAL P/N: WIN930MW5

To see our full line of products,

go to kvalinc.com and type in

sprocket

Find

Sprockets



Sprocket, 3512 X 1/2" Modified Bore, With Three R-6 Bearings

KVAL P/N: **BRO351202A**

Sprocket, 3516 X 1" Bore

KVAL P/N: **BRO351606**

Sprocket, 3518 X 3/4 Bore

KVAL P/N: **BRO351804**

Sprocket, 3520 X 3/4" Bore

KVAL P/N: **BRO352004**

Sprocket, 3520 X 1 Bore

KVAL P/N: **BRO352006**

Sprocket, 35H24, Use H Bushing

KVAL P/N: **BRO35H24**

Sprocket, 4014 X 1 Bore

KVAL P/N: **BRO401406**

Sprocket, 4016 X 1 Bore

KVAL P/N: **BRO401606**

Sprocket, 4018 X 1" Bore

KVAL P/N: **BRO401806**

Sprocket, 4020 X 1" Bore, 40BS20

KVAL P/N: **BRO402006**

Sprocket, 4026 X 3/4 Bore

KVAL P/N: **BRO402604**

Sprocket, 40G16 Taper Bore Use G Split Bushing, #40 Chain, 16 Tooth Sprocket

KVAL P/N: **BRO40G16**

Sprocket, 5021 X 1" Bore to Size Sprocket 50BS21 X 1

KVAL P/N: **BRO502106**

Sprocket, 5022 X 1 Bore To Size, Keyway and Set Screws

KVAL P/N: **BRO502208**

Sprocket, 50B24 X 1-1/4 Bore

KVAL P/N: **BRO502407**

Sprocket, 50B12, Modified Bored to 1-1/8" With 1/4 Keyway and 1/4 -20 SS at 0 and 90 Deg.

KVAL P/N: **BRO50B123M**



Sprockets



Sprocket, 12 Tooth 50 Chain, Modified 1" ID, 1/4 Key Way, Includes Modified Bushing

KVAL P/N: **BRO50G12M**



Sprocket, Tapered, H60H12, 1-3/8 Bore, Use H Bushing

KVAL P/N: **BROH60H12**



Taper Bushing, Split, H X 1-1/2

KVAL P/N: **BROH24**



Taper Bushing, Split, H X 24MM

KVAL P/N: **BROH24MM**

Spur Gear



Spur Gear, NSS08H24, Use with H Bushing

KVAL P/N: **BRO08H24**



Spur Gear, NSS 12F24, 1" Bore, 24 Tooth

KVAL P/N: **BRO12F246**



Spur Gear, NSS 12H36, Use with H Bushing

KVAL P/N: **BRO12H36**



Spur Gear, YSS 1620 X 5/8 Minimum Bore

KVAL P/N: **BRO1620Y1**



Spur Gear, YSS 1614 X 1/2, Modified Bore Hardened & Honed, 5/32 Roll Pin

KVAL P/N: **HNH1614Y2**



Spur Gear, YSS 1614 X 1/2, With Relief Machined on the Gear End, Modified Bore Hardened & Honed, 5/32 Roll Pin, OAL 1.170

KVAL P/N: **HNH1614Y3**



Spur Gear, S-1232 X 3/4, Modified S-1232 X 5/8

KVAL P/N: **MAR1232S4M**



Taper Bushings



Taper Bushing, Split, G X 1/2

KVAL P/N: **BROG08**



Taper Bushing, Split, G X 5/8

KVAL P/N: **BROG10**



Taper Bushing, Split, G X 7/8

KVAL P/N: **BROG14**



Taper Bushing, Split, G X 14MM

KVAL P/N: **BROG14MM**

To see our full line of products,

go to kvalinc.com and type in

Spur gear

Find



Taper Bushing, Split, G X 1

KVAL P/N: **BROG16**



Taper Bushing, Split, G X 19MM

KVAL P/N: **BROG19MM**



Taper Bushing, Split, G X 24MM

KVAL P/N: **BROG24MM**



Taper Bushing, Split, H X 1/2"

KVAL P/N: **BROH08**



Taper Bushing, Split, H X 5/8

KVAL P/N: **BROH10**



Taper Bushing, Split, H X 3/4

KVAL P/N: **BROH12**



Taper Bushing, Split, H X 7/8

KVAL P/N: **BROH14**



Taper Bushing, Split, 4016 X 1 Bore

KVAL P/N: **BROH16**



Taper Bushing, Split, H Style, 1-1/8 Bore

KVAL P/N: **BROH18**



Taper Bushing, Split, H X 19MM

KVAL P/N: **BROH19MM**



Taper Bushing, Split, H X 1-1/4

KVAL P/N: **BROH20**



Taper Bushing, Split, H Style, 1-3/8 Bore, 5/16 Keyway

KVAL P/N: **BROH22**



Taper Bushing, Split, H Style, 1-1/2 Bore

KVAL P/N: **BROH24**



Taper Bushing, Split, H X 24MM

KVAL P/N: **BROH24MM**

Belt Drives



Label, ISO, Hand Entanglement,
2.25" Base

KVAL P/N: LABELKVAL21B



Label, Warning,
Pinch Point, Keep
Hands Clear of
Rollers. Follow
Lockout Procedure
Before Servicing

5.50" X 2.70"

KVAL P/N: LABELKVAL22J



Label, Warning,
Pinch Point, Keep
Hands Clear of
Rollers. Follow
Lockout Procedure
Before Servicing

2.75" X 1.35"

KVAL P/N: LABELKVAL22L



Label, French, Point
De Pincement. Eloign-
er Les Mains Des
Rouleaux

2.75" X 1.35"

KVAL P/N: LABELKVAL60L

Chain Drives



Label, ISO, Hand Entanglement,
2.25" Base

KVAL P/N: LABELKVAL23B



Label, Danger, Crush Hazard,
5.50" X 2.70"

KVAL P/N: LABELKVAL24J



Label, Danger, Crush Hazard,
2.75" X 1.35"

KVAL P/N: LABELKVAL24L

Crush Hazards



Label Maintenance Personnel"
Danger Door Clamp May Crash to
Floor

KVAL P/N: LABEL-HANDLER



Label, Danger,
Pinch Point, 5.50"
X 2.70"

KVAL P/N: LABELKVAL26J



Label, Danger, Crush Hazard,
5.50" X 2.70"

KVAL P/N: LABELKVAL27J



Label, Danger, Crush Hazard,
2.75" X 1.35"

KVAL P/N: LABELKVAL27L



Label, Warning,
Crush Hazard,
5.50" X 2.70"

KVAL P/N: LABELKVAL28J



Label, ISO, Hand Crush, 2.25"
Base

KVAL P/N: LABELKVAL46B



Label, ISO, Hand Crush, 2.25"
Base

KVAL P/N: LABELKVAL51B



Crush Hazards



Label, ISO, Body Crush / Force From Above, 2.25" BASE

KVAL P/N: LABELKVAL55B



Label, Hand Crush/Roller Pinch Point, 2.25" Base

KVAL P/N: LABELKVAL65B



Label, Danger, Pinch Point, Moving Part Can Crush or Cut, Keep Clear, 5.50" X 2.70"

KVAL P/N: LABELKVAL66J



Label Danger Keep Fingers Clear...While in Motion, 3-1/2 X 5

KVAL P/N: LABELKVAL56B



Label, Warning, Pinch Point, Keep Hands Clear During Operation, 5.50" X 2.70"

KVAL P/N: LABELKVAL52J



Label, Warning, Pinch Point, Keep Hands Clear During Operation, 2.75" X 1.35"

KVAL P/N: LABELKVAL52L

Cutting Hazards



Label, Warning, Rotating Cutter Head, 5.50" x 2.70"

KVAL P/N: LABELKVAL14J



Label, Warning, Rotating Cutter Head, 2.75" X 1.35"

KVAL P/N: LABELKVAL14L



Label, Warning, Rotating Cutter Head, Vertical, 5.50" x 2.70"

KVAL P/N: LABELKVAL15J



Label, Warning, Rotating Cutter Head, 5.50" x 2.70"

KVAL P/N: LABELKVAL16J



Label, Warning, Rotating Cutter Hazard, 5.50" x 2.70"

KVAL P/N: LABELKVAL17J



Label, ISO, Cutting of Fingers or Hand, 2.25" Base

KVAL P/N: LABELKVAL18B



Label, ISO, Cutting of Fingers or Hand, 2.25" Base

KVAL P/N: LABELKVAL19B



Label, Warning, Rotating Blade Hazard, 5.50" X 2.70"

KVAL P/N: LABELKVAL20J

To see our full line of products,

go to kvalinc.com and type in

Electrical hazards

Find



Label, Danger, Pinch Point, 2.75" X 1.35"

KVAL P/N: LABELKVAL26L



Label, Danger, 979-2 Saw Blade

KVAL P/N: LABELKVAL53



Label, Danger, 979-2 Saw Blade, Spanish

KVAL P/N: LABELKVAL22L



Label, Danger, 979-2 Saw Blade, French

KVAL P/N: BROG14MM

Pressure Hazards



Label, Warning, To Avoid Possible Injury Lockout Pneumatic Power Before Servicing, 2.75" X 1.35"

KVAL P/N: LABELKVAL68L

Safety Instruction



Label, Danger, Read and Understand Instruction Manual, Label For All KVAL Machines.

KVAL P/N: LABELKVAL11

Read Manual



Label, Consult Operator's Manual, 2.00" Dia.

KVAL P/N: LABELKVAL45B



Label, Warning, Read and Understand Operator's Manual Before Using This Machine. 5.50" X 2.70"

KVAL P/N: LABELKVAL45J

Lifting Hazards



Label, Warning, Do Not Lift Here, 2.75" X 1.35"

KVAL P/N: LABELKVAL67L



Label, Forklift Point Right, 2.25" Base

KVAL P/N: LABELKVAL76B



Label, Forklift Point Left, 2.25" Base

KVAL P/N: LABELKVAL77B



Electrical Hazards



480 VOLTS

Label, Voltage, 480 Volts

KVAL P/N: LABELKVAL37



Label, French, Avertissement, Tension Dangereuse présente lorsque l'alimentation du disjoncteur principal est coupée. 5.00 X 2.00

KVAL P/N: LABELKVAL73



Label, Danger, Hazardous Voltage, Contact may cause electric shock or burn
Turn of and Lock out system power before servicing
4.00 X 2.00

KVAL P/N: LABELKVAL75K



Label, ISO, Electrical Shock, 3.80" Base

KVAL P/N: LABELKVAL48A



Label, ISO, Electrical Shock, 2.25" Base

KVAL P/N: LABELKVAL48B



Label, ISO, Electrical Shock, 1.30" Base

KVAL P/N: LABELKVAL48C

Gears



Label, Danger, Moving Parts Can Crush and Cut, 5.50" X 2.70"

KVAL P/N: LABELKVAL25J



Label, Danger, Moving Parts Can Crush and Cut, 2.75" X 1.35"

KVAL P/N: LABELKVAL25L



Label, French, Les Pièces Mobiles Peuvent Ecraser ET Couper

5.50" X 2.70"

KVAL P/N: LABELKVAL61J

Guards

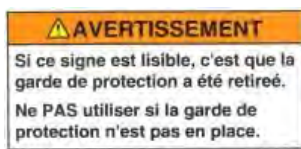

Label, French, Avertissement, Si CE Signe Est Lisible....
5.50 X 2.70

KVAL P/N: LABELKVAL44J-FR



Label, ISO, Stay Clear
2.00" Dia.

KVAL P/N: LABELKVAL56B



Label, ISO, Do Not Operate With Guard Removed
2.00" Dia

KVAL P/N: LABELKVAL57B



Label, ISO, Do Not Operate With Guard Removed / Gears Beneath
2.00" Dia

KVAL P/N: LABELKVAL59B

To see our full line of products,

go to kvalinc.com and type in

label

Find



Label Warning Keep Guards in Place, 3-1/2" X 5"

KVAL P/N: LABELKVAL18B



Label Danger Unguarded Machinery, 3-1/2" X 5"

KVAL P/N: LABELKVAL19B



Label Caution Do Not Reach Into Running Equipment, 1-1/2" X 2-1/2"

KVAL P/N: LABELSQS17



Label, Warning, Avoid Injury, Do Not Operate Machine Without All Guards in Place. 5.50" X 2.70"

KVAL P/N: LABELKVAL43J



Label, Warning, Avoid Injury, Do Not Operate Machine Without All Guards in Place. 2.75" X 1.35"

KVAL P/N: LABELKVAL53

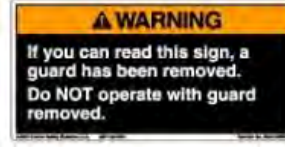

Label, Warning, If You Can Read This Sign a Guard Has Been Removed. Do Not Operate With Guard Removed. 5.50" X 2.70"

KVAL P/N: LABELKVAL44J

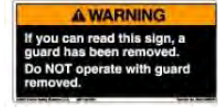

Label, Warning, If You Can Read This Sign a Guard Has Been Removed. Do Not Operate With Guard Removed. 2.75" X 1.35"

KVAL P/N: LABELKVAL44L

Indication Labels



Label, Grease Here, 2" X .5"

KVAL P/N: LABELKVAL78



Label, Lubrication Point, 2" X .5"

KVAL P/N: LABELKVAL79

Informational

HAND POSITION
FOR JAMB FEED



Label Hand Position for Jamb Feed With Arrow, 1-1/2" X 3"

KVAL P/N: LABELKVAL3



Label, USA Flag, 3" X 5"

KVAL P/N: LABELKVAL49



Label, KVAL Service Parts Maintenance 800 Phone Number, 3" X 4"

KVAL P/N: LABELKVAL50



Label, Grease Maintenance Schedule, EP-2 Grease Only

KVAL P/N: LABELKVAL54



Label, Caution Equipment Starts Automatically, 5.50" X 2.70"

KVAL P/N: LABELKVAL63

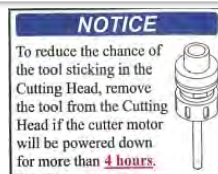

Label, DL-NCB Tool Changer Notice

KVAL P/N: LABELKVAL64



Label Red Arrows 18 Per Strip, 1/2" X 2-1/4"

KVAL P/N: LABELQS3010



Label Caution Routers Continue to Run at a Low Speed When Not Machining,



English|Spanish

KVAL P/N: LABEL-SPANISH



Label Caution Routers Continue to Run at a Low Speed When Not Machining,



English|French

KVAL P/N: LABELKVAL58

Personal Protective Equipment



Label, Caution, Eye Protection Required, 5.50" X 2.70"

KVAL P/N: LABELKVAL39J



Label, Caution, Eye Protection Required, 2.75" X 1.35"

KVAL P/N: LABELKVAL39L



Label, ISO, Wear Eye Protection, 2.00" Dia

KVAL P/N: LABELKVAL40B



Label, ISO, Wear Ear Protection, 2.00" Dia.

KVAL P/N: LABELKVAL41B



Label, Caution, Loud Noise Hazard, Ear Protection Must Be Worn, 5.50" X 2.70"

KVAL P/N: LABELKVAL42J



Label, Caution, Loud Noise Hazard, Ear Protection Must Be Worn, 2.75" X 1.35"

KVAL P/N: LABELKVAL42L



Accessories

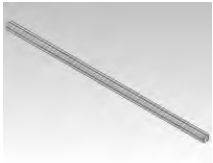

CAGE POST, ALUMINUM EXTRUSION, 2 X 2 X 72

KVAL P/N: 1350C



CAGE POST, ALUMINUM EXTRUSION, 2 X 2 X 84

KVAL P/N: 1351C



CAGE POST, ALUMINUM EXTRUSION, 2 X 2 X 98

KVAL P/N: 1352C



CAGE LABEL PLATE, ELECTRO GALVANNEALED STEEL 24 GA X 5-3/4 X 6.189 WITH TABS AT CORNERS.

KVAL P/N: 1355C



CAGE, ON-3 CAGE CROSS MEMBER, ALUMINUM EXTRUSION 2 X 2 X 119"

KVAL P/N: 1356C

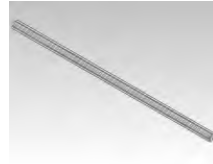

CAGE, ON-3 CAGE CROSS MEMBER, ALUMINUM EXTRUSION 2 X 2 X 192"

KVAL P/N: 1357C

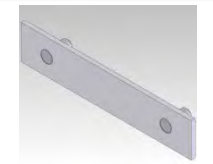

SAFETY CAGES, POST CLAMP BRACKET; LARGE DOUBLE T-NUT 5/8 STUD.

KVAL P/N: 161-00-05

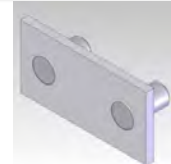

SAFETY CAGES, POST CLAMP BRACKET; SMALL DOUBLE T-NUT 5/8 STUD.

KVAL P/N: 161-00-06

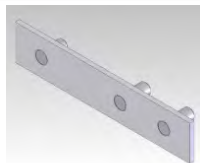

SAFETY CAGES, POST CLAMP BRACKET; TRIPLE T-NUT 5/8 STUD.

KVAL P/N: 161-00-07

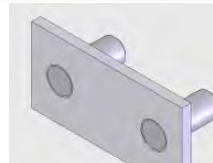

SAFETY CAGES, POST CLAMP BRACKET; SMALL DOUBLE T-NUT 3/4 STUD.

KVAL P/N: 161-00-09



SAFETY CAGES, LIMIT SWITCH MOUNTING BRACKET ASSEMBLY. (161-SW-AM WITH 2 X 1-1/4" 8/32 FLATHEAD SCREWS).

KVAL P/N: 161-00-20

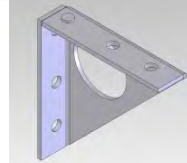

SAFETY CAGES, CORNER BRACKET, CRS 11GA (.119), ZINC COATED.

KVAL P/N: 161-00-AA



SAFETY CAGES, INFEED ROLL BRACKET, HRS 3/16 (.188) X 2.063 X 11.25", ZINC COATED.

KVAL P/N: 161-00-AF



SAFETY CAGES, POST BASE LEFT

KVAL P/N: 161-00-AJL



SAFETY CAGES, POST BASE RIGHT

KVAL P/N: 161-00-AJR



SAFETY CAGES, SWITCH PLATE

KVAL P/N: 161-00-AM

To see our full line of products,

go to kvalinc.com and type in

cages

Find

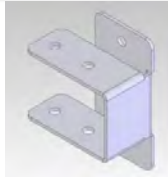
SAFETY CAGES,RAIL MOUNT
BRACKET,POST END

KVAL P/N: 161-00-AP

SAFETY CAGES,RAIL MOUNT
BRACKET,POST END

KVAL P/N: 161-00-AQ

SAFETY CAGES,POST-SCREEN
CLIP SINGLE 2 BOLT LEFT

KVAL P/N: 161-00-ARL

SAFETY CAGES,POST-
SCREEN CLIP SINGLE 2 BOLT
RIGHT

KVAL P/N: 161-00-ARR

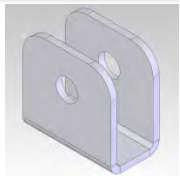
SAFETY CAGES,OPT.SL,GATE
ROLLER

KVAL P/N: 161-SL-AE

SAFETY CAGES,OPT.SL,LATCH
PLATE

KVAL P/N: 161-SL-AH

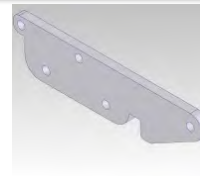
SAFETY CAGES,SLIDE
DOOR,LATCH

KVAL P/N: 161-SL-AI

SAFETY CAGES,OPT.SL,TRACK
PLATE

KVAL P/N: 161-SL-AO

SAFETY CAGES,OPT.SL,GATE
TOP FRAME, CRS 10GA (.135) X
34-5/8" LONG

KVAL P/N: 161-SL-AW

SAFETY CAGES,OPT.SL,DOOR
SLIDE CONNECTOR, CRS 3/4
DIA. X 11-3/4"

KVAL P/N: 161-SL-BA

SAFETY CAGES,OPT.SL SLIDING
DOOR, UNISTRUT TUBE,P1000 X
72"

KVAL P/N: 161-SL-BB

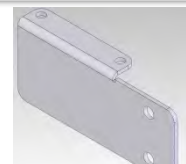
SAFETY CAGES,OPT.SL,GATE
GUIDE

KVAL P/N: 161-SL-BC

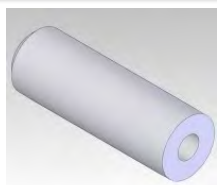
SAFETY CAGES,OPT.SL,DOOR
PIN GUIDE, CRS 1/2 DIA. X 1-1/2"

KVAL P/N: 161-SL-BD

SAFETY CAGES,OPT SW
SWINGING DOOR,LIMIT SWITCH
PLATE

KVAL P/N: 161-SW-AM

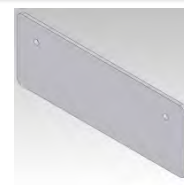
SAFETY CAGES,OPT SW SWING-
ING DOOR,DOOR STOP, SHEET
METAL,10 GA X 2-3/4 X 7-1/2.

KVAL P/N: 161-SW-BJ

SAFETY CAGES,LIMIT SWITCH
PIVOT SHAFT ASSEMBLY.

KVAL P/N: 161-SW-BK-0



Cross Bar



Lower cross bar assembly, Kit Includes: Posts, Corner Bracket, Hardware, Clips

KVAL P/N: 161-00-34

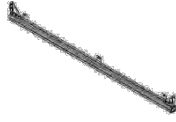

Upper cross bar assembly, Kit Includes: Posts, Corner Bracket, Hardware, Clips

KVAL P/N: 161-00-35

Accessories



CAGE POST, ALUMINUM EXTRUSION, 2 X 2 X 84

KVAL P/N: 1351C

Doors



Sliding Door Assembly, Kit Includes: Posts, Gate, Door Roller, Screens, Hardware

KVAL P/N: 161-SL-AW



Safety Cages, Slide Door, Safety Switch Kit, Includes: Limit Switch HS5B-11B, Key, Plate, Post Clamp, Hardware

KVAL P/N: 161-SL-800



Swing Gate Assembly, Kit Includes: Posts, Gate, Door Roller, Screens, Hardware

KVAL P/N: 161-SW-10RH



Safety Cages, Swing Door, Safety Switch Kit, Includes: Limit Switch E10001SCI, Pivot Shaft, Plate, Post clamp, Hardware

KVAL P/N: 161-SW-800

Panels

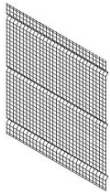

60 X 70 Mesh Panel, .135 Dia. X 2 X 2 Wire Mesh

KVAL P/N: 161-00-AS



30 X 70 Mesh Panel, .135 Dia. X 2 X 2 Wire Mesh

KVAL P/N: 161-00-AT

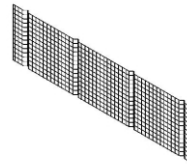

26 X 98 Mesh Panel, .135 Dia. X 2 X 2 Wire Mesh

KVAL P/N: 161-00-AV

To see our full line of products,

go to kvalinc.com and type in

Self Centering

Find



Post

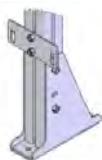

Straight 6', Center, Post Kit

KVAL P/N: 161-00-21

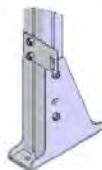

Left Corner 6' Post Kit

KVAL P/N: 161-00-22



Right Corner 6' Post Kit

KVAL P/N: 161-00-23

Safety Cages,
Left End 6'
Post Cages
Assembly.

KVAL P/N: 161-00-24



Right End 6' Post Kit

KVAL P/N: 161-00-25



Left End 7' Post Kit

KVAL P/N: 161-00-26



Left Corner 7' Post Kit

KVAL P/N: 161-00-27

Fastener, Concrete Wedge An-
chor, 3/8-16 X 5, Zinc

KVAL P/N: 375CWA500

Self Centering Bits

Self Centering Bit, Unit #5, 7/64"
Drill, For #5 & #6 Screws

KVAL P/N: VIXBIT05

Self-Centering Bit 9/64 Drill Unit
#9 for #8, 9 and 10 Screws.

KVAL P/N: VIXBIT09



Drill Bit, 9/64" For Vix Bit #9

KVAL P/N: VIXBIT09D

Self-Centering Bit #12 (11/64 Drill
Bit) (for #12 Screw).

KVAL P/N: VIXBIT12



Drill Bit, 11/64" For Vix Bit #12

KVAL P/N: VIXBIT12D





Arbors for Spin-On Bits



Arbor, Boring Chuck, 1/2" ID, 1" OD, 6" Long, 1/2" Shank

KVAL P/N: **KVABORCK6**



Arbor, 3/8" Dia. Shank, 1/4-28 Thread, 2-1/8" OAL

KVAL P/N: **KVARBOR06**



Arbor, 3/8" Dia. Shank, 1/4-28 Thread, 2-1/8" OAL With 5/32 Hole

KVAL P/N: **KVARBOR06A**



Arbor, 1/2" Dia. Shank, 1/4-28 Thread, 1-7/8" OAL, With 5/32 Hole

KVAL P/N: **KVARBOR06B**



Arbor 3/8" Dia. Shank 5/16-24 Thread 2-1/2 Long.

KVAL P/N: **KVARBOR07**



Arbor, 1/2" Dia. Shank, 1/4-28 Thread, 2-1/2" OAL, F3/F4 Without Hi Freq

KVAL P/N: **KVARBOR18A**



Arbor 1/2" Dia. Shank 1/4-28 Thread 2-3/8 OAL, Used on Backsection With 1 HP Perske MTR Hi Freq.

KVAL P/N: **KVARBOR18A1**



Arbor 1/2" Dia. Shank 5/16-24 Thread 2-1/2" Long, Used on 950-3 and 990F-3 and 4. Not Used on F3/F4 With Hi Freq

KVAL P/N: **KVARBOR18B**



Arbor 1/2" Dia. Shank 5/16-24 Thread 2-5/16 OAL, Used on 990F-3 & 990F-4 Hinge Router With Perske 1HP Hi Freq.

KVAL P/N: **KVARBOR18B1**



Arbor 1/2" Dia. Shank 5/16-24 Thread 3" Long, Used 990-F3 Front

KVAL P/N: **KVARBOR19**



Arbor 1/2" Dia. Shank 3-5/8" Long 1/4-28 Thread (1/16 Relief 1-5/8 Long).

KVAL P/N: **KVARBOR20**



Arbor 1/2" Dia. Shank X 2-7/8" Long 1/4-28 Thread. (3-1/8 With Threaded 1/4-28 End)

KVAL P/N: **KVARBOR21**



Arbor 1/2" Dia. Shank X 4" Long 1/4-28 Thread

KVAL P/N: **KVARBOR24**



Arbor 1/2" Dia. Shank X 4" Long 1/4-28 Thread (1/16 Relief 2-1/2 Back).

KVAL P/N: **KVARBOR25**



Arbor 1/2" Dia. Shank X 4" Long 5/16-24 Thread.

KVAL P/N: **KVARBOR26**



Arbor, 1/2" Dia. Shank, 1/4-28 Thread, 4" Long, 1/8" Relief 2-5/8" Back

KVAL P/N: **KVARBOR27**

To see our full line of products,

go to kvalinc.com and type in

Deep mortise

Find



Arbor, 1/2" Dia. Shank, 1/4-28 Thread, 6" Long

KVAL P/N: KVARBOR30



Arbor, 1/2" Dia. Shank, 1/4-28 Thread, 5-1/2" Long, .062 Relief 2 -15/16" Back.

KVAL P/N: KVARBOR32



Arbor, Router Bit, 1/4" Dia., 1/4-28 Thread, 1-13/16" Long

KVAL P/N: RBA250-1.75



Router Bit Arbor, 1/2 DIA, 1/4-28 THD, Left Hand, 2.375 LG.

KVAL P/N: RBA500-2.375LH



Router Bit Arbor, 1/2" Dia. Shank, 1/4-28 Thread, Left Hand, 3-1/8" Long

KVAL P/N: RBA500-3.125LH

Deep Mortise Arbors



Deep Mortise Arbor Shaft, Material: 1-5/8 Hex FM X 17-1/16" Long

KVAL P/N: 99M30CA



Deep Mortise Arbor Assembly (Complete Unit), Does Not Include Collet or Nut.

KVAL P/N: 99M33C



Deep Mortise Arbor Shaft 5/8" Shank 10-3/4" OAL 1/4-28 Thread

KVAL P/N: KVADMSH15



Deep Mortise Arbor Shaft 5/8" Shank 10-3/4" OAL 3/8-24 ID Thread.

KVAL P/N: KVADMSH16



Deep Mortise Arbor Shaft, 7/8" Dia., 6-5/8" OAL, 1/2" Shank, 1/4-28 Thread

KVAL P/N: KVADMSH16104



Deep Mortise Arbor Shaft, 7/8" Dia., 6-5/8" OAL, 1/2" Shank, 5/16-24 Thread

KVAL P/N: KVADMSH16105



Deep Mortise Arbor Shaft, 7/8" Dia., 6-5/8" OAL, 3/8-24 Thread

KVAL P/N: KVADMSH16106



Deep Mortise Arbor Shaft 7/8" Dia. 6 3/8 OAL 3/8 - 24 Thread

KVAL P/N: KVADMSH16108



Deep Mortise Arbor Shaft, 7/8" Dia, 8-5/8" OAL, 3/8-24 Thread

KVAL P/N: KVADMSH16138

Door Lite Router Bits—Steel Door



Router Bit, 3/16" Carbide Cutter, 1/4" Shank, 1/2" CL, 2" OAL

KVAL P/N: ACEDL01

ONSRUD



Router Bit, Onsrud 15-53, 1/2" Dia. X 3" Cutting Edge 5-1/2" - OAL, Door Lite Bits

KVAL P/N: ONS1553

ONSRUD



Router Bit, Onsrud 15-53, 1/2" Dia. X 3" Cut Edge Gold-Tin Coating 5-1/2" OAL, Door Lite Bits

KVAL P/N: ONS1553G

ONSRUD



Router Bit, Onsrud 15-53, 1/2" Dia., 3" Cut Edge With Flat, Gold-Tin Coating, 5-1/2" OAL

KVAL P/N: ONS1553G.F

ONSRUD



Router Bit, Onsrud 15-53, 1/2" Dia. X 3" Cutting Edge, K-Coating, 5-1/2" OAL

KVAL P/N: ONS1553K

ONSRUD



Router Bit, Onsrud 15-54, 1/2" Dia X 3" Cutting Edge 5" OAL With Flats

KVAL P/N: ONS1554

ONSRUD



Router Bit, Onsrud 15-57, 1/2" Dia. X 3" Cutting Edge 5-1/2" OAL With Flats

KVAL P/N: ONS1557

ONSRUD



Door Lite Router Bit, Onsrud 15-60, 1/2" Dia. X 5-1/2" OAL - Gold-Tin Coating, HSS Downcut Spiral

KVAL P/N: ONS1560G

ONSRUD



Router Bit, Onsrud 15-60, 1/2" Dia. X 5-1/2" Cutting LDL Lock Blocks Door-Lite Bit - Gold-Tin Coating, With Flat

KVAL P/N: ONS1560G-F

ONSRUD



Router Bit, Onsrud 26721, 1/2-Dia., 3" Cutting Edge Hollow Metal, 5-1/2" OAL Tin Coated Special Hollow Metal Bit.

KVAL P/N: ONS26721G



Router Bit, 1/2" Dia., 1/2" Shank, 5-1/2" OAL, 3" CL Compression

KVAL P/N: RB0808550-K



Router Bits



Router Bit Carbide Tipped 5/16\"/>

KVAL P/N: **RB050840M**



Router Bit Carbide Tipped 3/8\"/>

KVAL P/N: **RB060642**



Router Bit Carbide Tipped 3/8\"/>

KVAL P/N: **RB060841**



Router Bit Carbide Tipped 3/8\"/>

KVAL P/N: **RB060841M**



Router Bit Carbide Tipped 1/2\"/>

KVAL P/N: **RB080433**



Router Bit, Carbide Tipped, 1/2\"/>

KVAL P/N: **RB080436**



Router Bit Carbide Tipped 1/2\"/>

KVAL P/N: **RB080440**



Router Bit Carbide Tipped 1/2\"/>

KVAL P/N: **RB080648**



Router Bit Carbide Tipped 1/2\"/>

KVAL P/N: **RB080844**



Router Bit Carbide Tipped 1/2\"/>

KVAL P/N: **RB080850**



Router Bit Carbide Tipped 1/2\"/>

KVAL P/N: **RB080866**



Router Bit Carbide Tipped 1/2\"/>

KVAL P/N: **RB080872**



Router Bit Carbide Tipped 1/2\"/>

KVAL P/N: **RB080880**



Router Bit Carbide Tipped 1/2\"/>

KVAL P/N: **RB080884**



Router Bit Carbide Tipped 1/2\"/>

KVAL P/N: **RB080888**



Router Bit Carbide Tipped 1/2\"/>

KVAL P/N: **RB080888F**

To see our full line of products,

go to kvalinc.com and type in

Router Bits

Find



Router Bit Carbide Tipped 9/16" Dia. 1/4" Shank 2-1/8" OAL 3/4" CE

KVAL P/N: **RB090434**



Router Bit Carbide Tipped 9/16" Dia. 1/2" Shank 3" OAL 1-1/4" CE

KVAL P/N: **RB090848**



Router Bit Carbide Tipped 5/8" Dia. 1/2" Shank 2-5/8" OAL 1" CE

KVAL P/N: **RB100842**



Router Bit, 5/8" Dia., Carbide Tipped, Stagger Cut, 1/2" Shank, 4-3/4" OAL, 2-1/4" Cut Length

KVAL P/N: **RBST1072D**



Router Bit, 3/4" Dia., 1/2" Shank, 3" OAL, 1-1/2 CL

KVAL P/N: **RB120848**



Router Bit, 13/16" Dia. X 7/8" Shank X 8" OAL, 2" Cut Length, Under Cut Rougher With 5" Under-cut

KVAL P/N: **RB131480-MIS**



Router Bit, Carbide Tipped, 1-1/4" Dia., 1/2" Shank, 2-7/8" OAL, 1-1/4 CL, 5/16-24 Tap Shank

KVAL P/N: **RB240846**

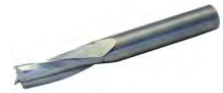

1/2" Dia. Slow Spiral Router Bit 1/2" CD X 1-1/2 CL X 1/2 Shank X 4" OAL X 3 Flute X Upcut (960-3)

KVAL P/N: **SOU-SRU606SL**

Door Lite Router Bits—Wood Door



Router Bit, 3/4" Dia., 3/4" Shank, 6" OAL, 2-3/4" CL, Two Flute Compression Spiral, 265 Series

KVAL P/N: **RB1212600-MIS**



Router Bit CT 1/2" Dia. 1/2" Shank 5-1/2". 2-1/2" Cutting Edge, Solid Carbide Two Flute Compression Spiral. Door lite Cutout Bit (For Wood and Fiberglass Only).

KVAL P/N: **RB-8311**



Router Bit Carbide Tipped 1/2" Dia. Stagger Cut 1/2" Shank 4-1/4" OAL 2-5/16" CE

KVAL P/N: **RBST0868D**

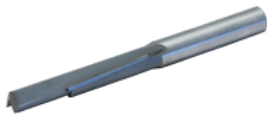

Router Bit Carbide Tipped 1/2" Dia. Stagger Cut 1/2" Shank 5" OAL 2-5/8" CE

KVAL P/N: **RBST0888D**



Router Bit Carbide Tipped 1/2" Dia. Stagger Cut 1/2" Shank 5-1/2" OAL With 2-5/8 Carbide Length

KVAL P/N: **RBST0888F-SE1**



Router Bit Carbide Tipped 1/2" Dia. Stagger Cut 1/2" Shank 5-1/2" OAL 2-5/8" CL.

KVAL P/N: **RBST0888F-WHI**

Spin-on Bits



Router Bit, Spin On, 1/4" Dia., 1/4-28 Thread, Straight Flute, Safranek

KVAL P/N: **RBSO250-SF**



Router Bit, Spin On, 3/8" Dia., 1/4-28 Thread, Straight Flute, Safranek

KVAL P/N: **RBSO375-SF**



Router Bit, Spin On, 7/16" Dia., 1/4-28 Thread, Reverse Helix.

KVAL P/N: **RBSO437**



Router Bit, Spin On, 1/2" Dia., 1/4-28 Thread, Reverse Helix

KVAL P/N: **RBSO500**



Router Bit, Spin On, 1/2" Dia., 1/4-28 Thread, Left Hand, Reverse Helix

KVAL P/N: **RBSO500-LH**



Router Bit, Spin On, 1/2" +.005" Dia., 1/4-28 Thread, Reverse Helix.

KVAL P/N: **RBSO505**



Router Bit, Spin On, 1/2" +.015" Dia., 1/4-28 Thread, Reverse Helix

KVAL P/N: **RBSO515**



Router Bit, Spin On, 9/16" Dia., 1/4-28 Thread, Reverse Helix.

KVAL P/N: **RBSO563**



Router Bit, Spin On, 5/8" Dia., 1/4-28 Thread, Reverse Helix.

KVAL P/N: **RBSO625**



Router Bit, Spin On, 5/8" +.005" Dia., 1/4-28 Thread, Reverse Helix.

KVAL P/N: **RBSO630**



Router Bit, Spin On, 5/8" +.015" Dia., 1/4-28 Thread, Reverse Helix.

KVAL P/N: **RBSO640**



Router Bit, Spin On, 11/16" Dia., 1/4-28 Thread, Reverse Helix.

KVAL P/N: **RBSO688**



Router Bit, Spin On, 3/4" Dia., 1/4-28 Thread, Reverse Helix.

KVAL P/N: **RBSO750**



Router Bit, Spin On, 3/4" +.015" Dia., 1/4-28 Thread, Reverse Helix.

KVAL P/N: **RBSO765**



Router Bit, Spin On, 7/8" Dia., 1/4-28 Thread, Reverse Helix.

KVAL P/N: **RBSO875**



Router Bit, Spin On, 15/16" Dia., 3/8-24 Thread, Drill End

KVAL P/N: **RBSO937-DE**

To see our full line of products,

go to kvalinc.com and type in

Spin-on

Find



Router Bit, Spin On, 31/32" Dia., 1/4-28 Thread, Reverse Helix

KVAL P/N: **RBSO969**



Router Bit, Spin On, 1" Dia., 1/4-28 Thread, Reverse Helix

KVAL P/N: **RBSO1000**



Router Bit, Spin On, 1" Dia., 3/8-24 Thread, Drill End

KVAL P/N: **RBSO1000-DE**



Router Bit, Spin On, 1-1/16" Dia., 1/4-28 Thread, Reverse Helix.

KVAL P/N: **RBSO1062**



Router Bit, Spin On, 1-1/8" Dia., 1/4-28 Thread, Reverse Helix.

KVAL P/N: **RBSO1125**



Router Bit, Spin On, 1-1/8" Dia., 3/8-24 Thread, Drill End

KVAL P/N: **RBSO1125-DE**

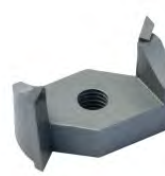

Router Bit, Spin On, 1-1/4" Dia., 1/4-28 Thread

KVAL P/N: **RBSO1250-4**



Router Bit, Spin On, 1-1/4" Dia., 5/16-24 Thread

KVAL P/N: **RBSO1250-5**



Router Bit, Spin On, 1-1/4" Dia., 1/4-28 Thread, Replaceable Carbide, Reverse Helix.

KVAL P/N: **RBSO1250-RCH**

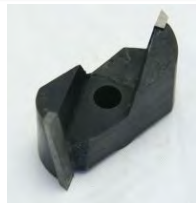

Router Bit, Spin On, 1-3/8" Dia., 1/4-28 Thread, Reverse Helix.

KVAL P/N: **RBSO1375**



Router Bit, Spin On, 1-1/2" Dia., 1/4-28 Thread, Reverse Helix.

KVAL P/N: **RBSO1500**

Replacement Blades



Router Bit Cutter Blade Replacement, 12 X 12 X 1.5, Set of 10.

KVAL P/N: **RBCB12R-10**



Screwdriver Bits



Bit, Phillips 1953-1 Square Recess Head Drive Bit, 3-1/2" OAL, Screw Size 5-6-7

KVAL P/N: APE19531



Bit, Phillips 1953-2 Roberts Square Head Drive Bit

KVAL P/N: APE19532



Bit, Phillips 440-2 Bit, 1/4 X 1" Long for #5 - #9 Screws

KVAL P/N: APE4402



Bit, Phillips 1/4 X 1 Long Point Size 3 440-3 Bit

KVAL P/N: APE4403



Bit, Phillips #2 Head, 6" OAL, Full Body Turned Diameter
Substitute for: APE492CC

KVAL P/N: VEG492CC



Bit, Phillips 10-32 Screw Shank (Min. 10+) Phillips Head 1 1/2 OAL

KVAL P/N: APE502



Bit, Phillips 10-32 Thread 1/4 X 1-13/16" OAL

KVAL P/N: APE502AX



Bit, Phillips Screw-on Shank, OAL 1 3/16, .300 Dia.

KVAL P/N: APE552I



Bit Phillips #2 Tip 3-1/2" Extra Hard Used on KVAL 6 Shooter

KVAL P/N: KVAL492BI

Solid Carbide



Router Bit, Solid Carbide, 1/2" Dia. X 1/2" Shank X 3" OAL X 1-1/4" CL

KVAL P/N: **RBSC0808300**



Router Bit, Solid Carbide, 1/2" Dia. X 1/2" Shank X 3-1/2" OAL X 1-5/8" CL 2 Flute Downcut

KVAL P/N: **RBSC0808350**



Router Bit, 1/2" Dia. X 1/2" Shank X 5" OAL, 2.7" Flute Up-Shear & Down-Shear, Compression Bit, ESG Coating, Solid Carbide

KVAL P/N: **RBSC0808500-E**



Router Bit, Solid Carbide, 1/2" Dia. X 1/2" Shank X 5" OAL X 2-3/4" CL 2 Flute Downcut, Left Hand

KVAL P/N: **RBSC0808500-L**



Router Bit, Solid Carbide, 1/2" Dia. X 1/2" Shank X 5-1/2" OAL X 2-3/4" CL 2 Flute Compression Bit

KVAL P/N: **RBSC0808550**



Router Bit, 5/8" Dia. X 5/8" Shank X 5" OAL, 2-1/4" Cutting Length, 2 Flute Spiral Chip breaker Compression Bit, Solid Carbide

KVAL P/N: **RBSC1010500**



Router Bit, Solid Carbide, Left Hand, 3/4" Dia. X 3/4" Shank X 6" OAL, 2-1/2" CL, 2 Flute Reversible Compression with Under Cut

KVAL P/N: **RBSC1212600-LH**



Router Bit, Solid Carbide, 3/4" Dia. X 3/4" Shank X 8" OAL X 2.2" CL Up Cut, 2 Flute Rougher With 5-1/2" Spiral Relief

KVAL P/N: **RBSC1212800**



Router Bit, Solid Carbide, 7/8" Dia. X 7/8" Shank X 8" OAL X 2.2" CL Up Cut, 2 Flute Rougher With 5-1/2" Spiral Relief

KVAL P/N: **RBSC1414800**



Router Bit, Solid Carbide, 1" Dia. X 1" Shank X 8" OAL X 2.2" CL Up Cut, 2 Flute Rougher With 5" Spiral Relief.

KVAL P/N: **RBSC1616800**



Router Bit, 1/2" Dia. X 1/2" Shank X 3" OAL, 1-1/4" Flute Down Shear, Solid Carbide

KVAL P/N: **RB0808300-MISDC**



Router Bit, 3/8" Dia. X 3/8" Shank X 3" OAL, 1-1/4" Cutting Length, Double Edge Spiral Right Hand/ Down Cut, Solid Carbide

KVAL P/N: **RB7073DR**



Router Bit, 1/2" Dia. X 1/2" Shank X 4" OAL, 2" Cutting Length, Double Edge Spiral Right Hand/Down Cut, Solid Carbide

KVAL P/N: **RB7076DR**

To see our full line of products,

go to kvalinc.com and type in

Dowell Drill

Find



Dowell Drill



Dowel Drill, 3/8" Dia., 3" RH Twist, 4-1/2" OAL, 7/16 NC Thread
KVAL P/N: DD24H7



Dowel Drill, 25/64" Dia., 3" RH Twist, 4-1/2" OAL, 7/16 NC Thread
KVAL P/N: DD25H7



Dowel Drill, 7/16" Dia., 3" RH Twist 4-1/2" OAL 7/16 NC THD
KVAL P/N: DD28H7



Dowel Drill, 29/64" Dia., 3" RH Twist, 4-1/2" OAL, 7/16 NC Thread
KVAL P/N: DD29H7



Dowel Drill, 7/8" Dia., Carbide Tipped, 3" RH Twist, 4-1/2" OAL, 7/16 NC Thread
KVAL P/N: DD56H7C



Dowel Drill, 15/16 Dia., Carbide Tipped, 3" RH Twist, 4-1/2" OAL,
KVAL P/N: DD60H7X-CT



Dowel Drill, 13/32" Dia., 3" RH Twist, 4-1/2" OAL, 7/16 NC Thread
KVAL P/N: DD62013



Dowel Drill, 1 Dia., 3" RH Twist, 4-1/2" OAL, 7/16 NC Thread
KVAL P/N: DD64H7



Twist Drill, 1" Dia., 7/16" Screw On, 4" Twist, Brad Point, Carbide Tipped.
KVAL P/N: TD1664-BPCT7

High Speed Drill Bit—Jobber Drills

Molybdenum Tungsten high-speed steel. Heat-treated and precision-ground for hardness and accuracy. Use for metal, plastic and wood. Jobber bits have a 118° point.



JLD0938	Drill Bit, 3/32" Jobber Length High Speed Steel
JLD1250	Drill Bit, 1/8" Jobber Length High Speed Steel
JLD1563	Drill Bit, 5/32" Jobber Length High Speed Steel
JLD1719	Drill Bit, 11/64" Jobber Length High Speed Steel
JLD2031	Drill Bit, 13/64" Jobber Length High Speed Steel
JLD2500	Drill Bit, 1/4" Jobber Length High Speed Steel
JLD3125	Drill Bit, 5/16" Jobber Length High Speed Steel



High Speed Drill Bit—Stub Drills

Molybdenum Tungsten high-speed steel. Heat-treated and precision-ground for hardness and accuracy. Use for metal, plastic and wood. Stub bits have a 135° point.



SLD1094	Drill Bit, High Speed Steel, 7/64" Stub Length
SLD1250	Drill Bit, High Speed Steel, 1/8" Stub Length
SLD1406	Drill Bit, High Speed Steel, 9/64" Stub Length
SLD1563	Drill Bit, High Speed Steel, 5/32" Stub Length
SLD1875	Drill Bit, High Speed Steel, 3/16" Stub Length
SLD2500	Drill Bit, High Speed Steel, 1/4" Stub Length
SLD3125	Drill Bit, High Speed Steel, 5/16" Stub Length

Multi Spur Bits

Router Bit, Multi Spur Bit, 1/2" Dia., 1/2" Shank
KVAL P/N: MSB08

Router Bit, Multi Spur Bit, 5/8" Dia., 1/2" Shank
KVAL P/N: MSB10

Router Bit, Multi Spur Bit, 7/8" Dia., Carbide Tipped, 1/2" Shank
KVAL P/N: MSB14-CT

Router Bit, Multi Spur Bit, 15/16" Dia., Carbide Tipped, 1/2" Shank
KVAL P/N: MSB15-CT

Router Bit, Multi Spur Bit, 1" Dia., 1/2" Shank
KVAL P/N: MSB16

Router Bit, Multi Spur Bit, 1" Dia., Carbide Tipped, 1/2" Shank
KVAL P/N: MSB16-CT

Router Bit, Multi Spur Bit, 1" Dia., Carbide Tipped, 1/2" Shank With
KVAL P/N: MSB16-CTF

Router Bit, Multi Spur Bit, 1-1/4" Dia., Carbide Tipped, 1/2" Shank
KVAL P/N: MSB20-CT

Router Bit, Multi Spur Bit, 1-1/2" Dia., Carbide Tipped, 1/2" Shank
KVAL P/N: MSB24-CT

Router Bit, Multi Spur Bit, 1-5/8" Dia., Carbide Tipped, 1/2" Shank
KVAL P/N: MSB26-CT

Router Bit, Multi Spur Bit, 2-1/8" Dia., Carbide Tipped, 1/2" Shank,
KVAL P/N: MSB34

Router Bit, Multi Spur Bit, 2-1/8" Dia., Carbide Tipped, 1/2" Shank,
KVAL P/N: MSB34-CTF

To see our full line of products,

go to kvalinc.com and type in

Twist drill

Find



Router Bit, Multi Spur Bit, 2-1/8" Dia., Carbide Tipped, 5/32 Rake,

KVAL P/N: MSB34-CTNS

Deep Drill



Tooling, Deep Drill, Rail STS .690 Dia., 5/8" Shank X 17" OAL, Carbide Tipped

KVAL P/N: DEEPDR17



Deep Drill, .690 DIA X 5/8" Shank X 30" With Carbide Tip

KVAL P/N: DEEPDR30



Tooling, Deep Drill, .690 Dia., 5/8" Shank x 42" OAL, Carbide Tipped, .690 Bearing Ring

KVAL P/N: DEEPDR42

Twist Drills



Twist Drill, 15/16" Dia., 4" Twist, Brad Point, 1/2" Shank, 6" OAL,

KVAL P/N: GREX20058



Drill Bit, 5/16" Dia., HSS Brad Point Drill, 3" Twist X 1/2" Shank X

KVAL P/N: SOU-SE19105



Drill Bit, 13/32" Dia., HSS Brad Point Drill, 3" Twist X 1/2" Shank X

KVAL P/N: SOU-SE19109



Twist Drill, 1/4" Dia. X 70mm Long, 10 X 23 Shank Brad Point, Right

KVAL P/N: TD0470-BP



Twist Drill, 4mm Dia., 70mm Long, 10 X 23 Shank Brad Point, Right

KVAL P/N: TD04M70-BP



Twist Drill, 3/8" Dia. , 4" Twist, Brad Point, Carbide Tipped, 1/2" Shank,

KVAL P/N: TD0664-BPCT



Twist Drill, 3/8" Dia., 4" Twist, Brad Point, 3/8" Modified Shank, 6" OAL.

KVAL P/N: TD0664-BPM



Twist Drill, 7/16" Dia., 3" Twist, Brad Point, 3/8" Modified Shank, 5" OAL.

KVAL P/N: TD0748-BPM



Twist Drill, 1/2" Dia., 4" Twist, Brad Point, Carbide Tipped, 1/2" Shank,

KVAL P/N: TD0864-BPCT



Twist Drill, 7/8" Dia., 4" Twist, Brad Point, Carbide Tipped, 1/2" Shank,

KVAL P/N: TD1464-BPCT



Twist Drill, 7/8" Dia., 6" Twist, Brad Point, Carbide Tipped, 1/2" Shank,

KVAL P/N: TD1496-BPCT



Twist Drill, 15/16" Dia., 4" Twist, Brad Point, Carbide Tipped, 1/2"

KVAL P/N: TD1564-BPCT



Twist Drill, 15/16" Dia., 7/16 Thread Screw On, 4" Twist, Brad Point,

KVAL P/N: TD1564-BPCT7



Twist Drill, 15/16" Dia., 6" Twist, Brad Point, 1/2" Shank, 8-1/4" OAL.

KVAL P/N: TD1596-BP



Twist Drill, 15/16" Dia., 6" Twist, Brad Point, Carbide Tipped, 1/2"

KVAL P/N: TD1596-BPCT



Twist Drill, 1" Dia., 4" Twist, Brad Point, 1/2" Shank, 6" OAL.

KVAL P/N: TD1664-BP



Twist Drill, 1" Dia., 4" Twist, Brad Point, Carbide Tipped, 1/2" Shank,

KVAL P/N: TD1664-BPCT



Twist Drill, 1" Dia., 7/16" Screw On, 4" Twist, Brad Point, Carbide Tipped.

KVAL P/N: TD1664-BPCT7



Twist Drill, 1" Dia., 4" Twist, Brad Point, Carbide Tipped, 1/2" Shank

KVAL P/N: TD1664-BPCTF



Twist Drill, 1" Dia., 6" Twist, Brad Point, Carbide Tipped, 1/2" Shank, 8

KVAL P/N: TD1696-BPCT

To see our full line of products,

go to kvalinc.com and type in

Wing Bit

Find



Two-Stage Bits



Drill, 2-Stage, 1-1/2" Dia., 2-1/8" Dia., All Carbide Tipped

KVAL P/N: 2SD24-34



Drill, 2-Stage, 1-5/8" Dia., 2-1/8" Dia., All Carbide Tipped

KVAL P/N: 2SD26-34



Counterbalance, 1/2" ID X 1" OD X 1-3/4" Long

KVAL P/N: CB500

Wing Bits



Router Bit, 2-Wing, 2-1/8" Dia., Carbide Tipped, 1/2" Shank

KVAL P/N: 2WB34-CT



Router Bit, 2-Wing, 2-1/8" Dia., Carbide Tipped, 1/2" Shank, With

KVAL P/N: 2WB34-CTF



Router Bit, 2-Wing, 2-1/8" Dia., Carbide Tipped, 1/2" Shank

KVAL P/N: 2WB34-CT-INTC



Router Bit, 2-Wing, 2-1/8", Insert Drill With Replaceable Carbide

KVAL P/N: 2WB34-RC



Router Bit 3-Wing, 1/2" Dia., Carbide Tipped, 1/2" Shank, 6" OAL

KVAL P/N: 3WB08-CT



Router Bit 3-Wing, 9/16" Dia., Carbide Tipped, 1/2" Shank, 6" OAL

KVAL P/N: 3WB09-CT



Router Bit 3-Wing, 5/8" Dia., Carbide Tipped, 1/2" Shank, 6" OAL

KVAL P/N: 3WB10-CT



Router Bit 3-Wing, 3/4" Dia., Carbide Tipped, 1/2" Shank, 6" OAL

KVAL P/N: 3WB12-CT



Router Bit 3-Wing, 7/8" Dia., Carbide Tipped, 1/2" Shank, 6" OAL

KVAL P/N: 3WB14-CT



Router Bit 3-Wing, 1" Dia., Carbide Tipped, 1/2" Shank, 6" OAL

KVAL P/N: 3WB16-CT



Router Bit 3-Wing, 1-1/8" Dia., Carbide Tipped, 1/2" Shank, 6"

KVAL P/N: 3WB18-CT



Router Bit 3-Wing, 1-1/4" Dia., Carbide Tipped, 1/2" Shank, 6" OAL

KVAL P/N: 3WB20-CT



Router Bit 3-Wing, 1-3/8" Dia., Carbide Tipped, 1/2" Shank, 6"

KVAL P/N: 3WB22-CT



Router Bit 3-Wing, 1-1/2" Dia., Carbide Tipped, 1/2" Shank, 6"

KVAL P/N: 3WB24-CT



Router Bit 3-Wing, 1-5/8" Dia., Carbide Tipped, 1/2" Shank, 6" OAL

KVAL P/N: 3WB26-CT



Router Bit, 3-Wing, 1-3/4" Dia., Carbide Tipped, 1/2" Shank, 6" OAL

KVAL P/N: 3WB28-CT



Router Bit, 3-Wing, 1-7/8" Dia., Carbide Tipped, 1/2" Shank, 6" OAL

KVAL P/N: 3WB30-CT



Router Bit 3-Wing, 2" Dia., Carbide Tipped, 1/2" Shank, 6" OAL

KVAL P/N: 3WB32-CT



Router Bit, 3-Wing, 2-1/8" Dia., Carbide Tipped, 1/2" Shank, 6" OAL

KVAL P/N: 3WB34-CT



Router Bit 3-Wing, 2-1/4" Dia., Carbide Tipped, 1/2" Shank, 6" OAL

KVAL P/N: 3WB36-CT



Router Bit, 3-Wing, 2-3/8" Dia., Carbide Tipped, 1/2" Shank, 6" OAL

KVAL P/N: 3WB38-CT



Chipouts



Chipout, DL-2, Door Cutoff Opt-B

KVAL P/N: 37-0B-AAA



700-C, Head, Vertical Jamb Clamp Block, Natural Canvas Phenolic, 1 X

KVAL P/N: 46-00-BX



Chipout, RCD/RE/Architect, Hinge Section 1/4 Radius

KVAL P/N: CHIPOUT01

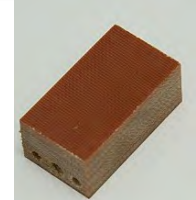

Chipout, RCD/RE Special, Hinge Section 1/4 Radius

KVAL P/N: CHIPOUT01A

Chipouts

To see our full line of products,

go to kvalinc.com and type in

Chipout

Find



Chipout, Architect, After 1998, Hinge Section 1/4 Radius

KVAL P/N: **CHIPOUT01B**



Chipout, RCD/RE/Architect, Hinge Section 5/8 Radius

KVAL P/N: **CHIPOUT03**



Chipout, 990 RCD, Hinge Section 5/8 Radius

KVAL P/N: **CHIPOUT03A**



Chipout, Architect, Hinge Section 5/8 Radius

KVAL P/N: **CHIPOUT03C**



Chipout, Back Section Lock Bevel

KVAL P/N: **CHIPOUT05**



Chipout, Back Section Function Hole-Upper Chipout Block, For 2-3/8", 2-3/4" and 5" Backset Manual Shift.

KVAL P/N: **CHIPOUT06**



Chipout, Back Section Function Hole-Upper Chipout Block, For 2-3/8", 2-3/4" and 5" Backset Manual Shift.

KVAL P/N: **CHIPOUT06A**



Chipout, 990, Hinge Section, 1-3/8 X 1-1/2 X 4-1/2

KVAL P/N: **CHIPOUT07**



Chipout, F3/F4, Hinge Section, 1-1/4 X 1-1/2 X 4-1/2 Spring Loaded,

KVAL P/N: **CHIPOUT09**



Chipout, F3/F4, Hinge Section, 1-1/8" X 1-1/2" X 4-1/2", Hinge Sect.

KVAL P/N: **CHIPOUT09A**



Chipout, F3/F4, Hinge Section, Spring Loaded, 1" X 1-1/2" X 4-1/2"

KVAL P/N: **CHIPOUT09B**



Chipout, 990-F3, Hinge Section, Natural Canvas Phenolic, 1-1/4 X 1-1/2 X 4-1/2. (MAPLE)

KVAL P/N: **CHIPOUT11**



Chipout, 979, Natural Canvas Phenolic, 1/2 X 1 X 6-1/2.

KVAL P/N: **CHIPOUT19**



Chipout, 977, Pre 1974, 1/2 X 5/8 X 6-1/2

KVAL P/N: **CHIPOUT20**



Chipout, 977, Natural Canvas Phenolic, 1 X 11/16 X 6-1/4

KVAL P/N: **CHIPOUT21**



Chipout, 990F-2, Facebore, Natural Canvas Phenolic, 5/16 X 4 X 12"

KVAL P/N: **CHIPOUT26**



Chipout, Edge, 1/4 Radius, 3/4 X 1 X 3-1/4

KVAL P/N: **CHIPOUT27**

Chipout, Edge, 1/4 Radius Ver. 1997, 3/4 X 1-7/16 X 3-1/4

KVAL P/N: **CHIPOUT27A**

Chipout, Edge, 1/4 Radius, Version 2005, 3/4 X 1.45 X 4.145

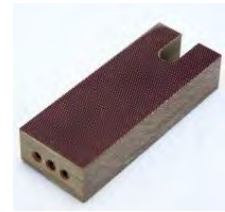
KVAL P/N: **CHIPOUT27AC**

Chipout, Edge, 1/4 Radius, 3/4 X 1-7/16 X 3-3/4, Ver 1998

KVAL P/N: **CHIPOUT27C**

Chipout, Edge, 5/8 Radius, 5/8 X 1-3/4 X 1-3/4

KVAL P/N: **CHIPOUT28**

Chipout, Commander, Front Section, 3/4 X 1 X 8.

KVAL P/N: **CHIPOUT30**

Chipout, Block 950-3/960-3, 7/8 x 1 X 9" Long Wood (955-C LH & RH)

KVAL P/N: **CHIPOUT35**

Chipout, 950-3, With 45 Deg. Chamfer on Both Top Edges, 3/4 X 1-3/16 x 10-1/2

KVAL P/N: **CHIPOUT35C**

Chipout, Commander, 1996+, Hinge Pass Through Hinge Pocket, 7"

KVAL P/N: **CHIPOUT39B**

Chipout, Back Section, Lower Drill Box Chipout With Function Hole Drill Option, 1/2 X 6 1/2 X 7 LG

KVAL P/N: **CHIPOUT49A**

Chipout, Back Section, Lower Drill Box Chipout With Function Hole Drill Option, Slotted For Drill Clearance, 1/2 X 6 1/2 X 7 LG

KVAL P/N: **CHIPOUT49A1**

Chipout, Architect, Thru Hinge Pocket, 5/16 X 1-1/4 X 7

KVAL P/N: **CHIPOUT61**

Chipout, Architect, Thru Hinge Pocket With Step, 5/16 X 1-1/4 X 7

KVAL P/N: **CHIPOUT61A**

Chipout, Architect, Option-M Thru Pocket, 5/16 X 1-1/4 X 7

KVAL P/N: **CHIPOUT61B**

Chipout, Lockblock, Face Bore, Natural Canvas Phenolic, 1/2 X 3 X

KVAL P/N: **CHIPOUT63**

Chipout, Miter Stop Saw, Delrin, 1/2 X 2-3/4 X 3-1/2

KVAL P/N: **CHIPOUT64**

To see our full line of products,

go to kvalinc.com and type in

Chipout

Find



Chipout, Miter Stop Saw, Delrin, 1/2 X 2-3/4 X 3-1/2

KVAL P/N: **CHIPOUT64D**



Chipout, Architect-DI, Hinge Router, 3/8 X 1-1/2 X 3-1/4

KVAL P/N: **CHIPOUT65**



Chipout, 979-2, Delrin, 1 X 31/32 X 7-31/32

KVAL P/N: **CHIPOUT73**



Chipout, 990 Series, Back Section, Raised Moulding Option, 1 X 3-1/2 X 7

KVAL P/N: **CHIPOUT75**



Chipout, Commander-Di, Hinge Router, 5/8" Radius (1-1/4" Bit), 3/4

KVAL P/N: **CHIPOUT77**



Chipout, Commander-Di, Hinge Router, 1/4" Radius (1/2" Bit), 3/4 X 1-1/8 X 1-3/8 LG

KVAL P/N: **CHIPOUT78**



Chipout, 990, Thru Pocket, 4 X 1-1/2" X 5-1/2

KVAL P/N: **CHIPOUT80**



Chipout, Commander-Di, Hinge Router, 1/4" Radius (1/2" Bit), 3/4

KVAL P/N: **CHIPOUT81**

Chisels



Chisel, 5/8" Radius Corner Chisel, W0058

KVAL P/N: **NORW0058**



Chipout, Commander-Di, Hinge Router, 5/8 Radius (1-1/4" Bit), 3/4 X 3/4 X 1-3/16

KVAL P/N: **CHIPOUT82**



Chipout, 990 Series, Hinge Jamb Thru Pocket, .750 X 2 X 15-1/2

KVAL P/N: **CHIPOUT83**



Corner Chisel - 1/4" Radius Hinge & Faceplate.

KVAL P/N: **POR42234**



Sipp Cutter Blade (#13)

KVAL P/N: **SIP013**



Cutter for the Model #65 Corner Square (Cutter #114).

KVAL P/N: **SIP038**



Tooling, SIPP, Cutter for the Model #65X Corner Square (CS-38X)

KVAL P/N: **SIP038X**

Chucks & Keys



990F, Front, Predrill Extended
Chuck Key with Chuck Key

KVAL P/N: 12-00-100



Chuck Key for 1BA Chuck, Key #1

KVAL P/N: JAC1BK



Chuck Key for 2B Chuck, Key #2

KVAL P/N: JAC2BK



Chuck 33BA 3/8-24 Thread Mount
5/64 To 1/2 Cap.

KVAL P/N: JAC33B1



Chuck Key (KEY #3) For Jacobs
Chuck.

KVAL P/N: JAC33BK



Chuck 5/16-24 Thread Mount 0-5/32
Capacity

KVAL P/N: JACOB



Chuck Key for OB Series Chucks

KVAL P/N: JACOBK



Chuck Tapered 7/8", With CSK
WASH & 5/16 FH SCR, Use Nut
ACU940005 & ACUAF122 collet

KVAL P/N: KVASC0028



Chuck Tapered 1", With CSK WASH
& 5/16 FH SCR Use ACU940005
Nut and ACUAF122 1/2" Collet

KVAL P/N: KVASC0032

Collets & Cover Nuts



Cover Nut, ACU 9400005
(Backsection Lock Bore, M-2000,
Edge)

KVAL P/N: ACU940005



Collet, 1/2-3/4 Capacity
(Backsection Lock Bore & Bolt Drill)

KVAL P/N: ACUAF122



Collet, 5/8-3/4 Capacity (M-2000,
Old Edge, DP-1)

KVAL P/N: ACUAF130



1/2 Collet for HSD A6161H0824
Spindle

KVAL P/N: AER32 1/2

To see our full line of products,

go to kvalinc.com and type in

Collets

Find



1/2 Collet for Dewalt 628 and Black and Decker 2721 (Black and Decker 3328) DEW PN DW6905.

KVAL P/N: **BLA146551**



Collet, ER40 3/8", Colombo 10 HP and 11 HP High Frequency Motors.

KVAL P/N: **COLER06**



Collet, ER40 1/2", Colombo 10HP and 11HP High Frequency Motors.

KVAL P/N: **COLER08**



Collet, ER40 5/8", Colombo 10 HP and 11HP High Frequency Motors.

KVAL P/N: **COLER10**



Collet, ER40 3/4", Colombo 10 HP and 11HP High Frequency Motors.

KVAL P/N: **COLER12**



Collet, ER40 7/8", Colombo 10 HP and 11 HP High Frequency Motors.

KVAL P/N: **COLER14**



Collet, ER40 1", Colombo 10 HP and 11 HP High Frequency Motors.

KVAL P/N: **COLER16**



Collet, ER20, For 9/64" or 5/32" Tool

KVAL P/N: **COLER20-02.5**



Collet, ER20, For 3/16" Tool

KVAL P/N: **COLER20-03**



Collet, ER20, For 1/4" Tool

KVAL P/N: **COLER20-04**



Collet, ER20, For 5/16" Tool

KVAL P/N: **COLER20-05**



Collet, ER25 3/8", Colombo 3 HP and 7.5 HP High Frequency Motors.

KVAL P/N: **COLER25-06**



Collet, ER25 1/2", Colombo High Frequency Motors.

KVAL P/N: **COLER25-08**



Collet, ER25, 5/8", Colombo High Frequency Motors.

KVAL P/N: **COLER25-10**



Collet, ER25 3/4", Colombo 3 HP and 7.5 HP High Frequency Motors

KVAL P/N: **COLER25-12**

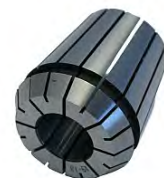

Collet, ER40, 18MM, Colombo High Frequency Motors.

KVAL P/N: **COLER40-18MM**

To see our full line of products,

go to kvalinc.com and type in

Collets

Find



Cover Nut, ER25, For 3HP Colombo High Frequency Motor

KVAL P/N: COLER25-C



Cover Nut, ER25, For 3HP Colombo High Frequency Motor, Mini

KVAL P/N: COLER25-C-M



Collet Nut, ER25, For Colombo 7.5 HP High Frequency Motors.

KVAL P/N: COLER25-C7



Cover Nut, ER40, 10 HP and 11HP Colombo Motor, Powder Coated

KVAL P/N: COLUMBO-NUT-ER40P



Collet, 1/2" Hardinge, 2 HP, Perske Motor. (Coated Inside Diameter)

KVAL P/N: HAR ER-20



B3 Collet, 1/2" Round, 7/16-20 Thread, Hardinge

KVAL P/N: HARB3



Collet, 1/2" 3/8-24 NF Thread

KVAL P/N: HARB4



Collet, 1/4", ER16, Perske .37 HP

KVAL P/N: PERER16-1/4"



Cover Nut, ER16M, KRS35.5-2 Perske Motor

KVAL P/N: PERER16C



Collet, 1/2", 1 and 2 HP, Perske Motors and 1.5 HP Colombo motor.

KVAL P/N: PERER20-1/2

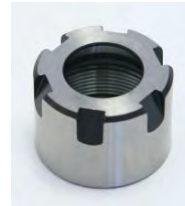

Cover Nut, ER20 (1/2) Collet Used on 1 HP and 2 HP Perske Motor.

KVAL P/N: PERER20C



Collet, 1/2" FRL90, 7.5-HP Perske Motor.

KVAL P/N: PERFRL90B



Collet, 7/8" FRL90, 7.5-HP Perske Motor.

KVAL P/N: PERFRL90E



Collet, 1" FRL90, 7.5-HP Perske Motor.

KVAL P/N: PERFRL90F



Collet, 25mm, FRL90, 7.5 HP Perske Motor

KVAL P/N: PERFRL90G



Cover Nut, FRL 90 M48 X 2 RH, 7.5 HP Perske Motor.

KVAL P/N: **PERFRL90N**



Collet, 1/2", Perske 3 HP VS 50-60 Motor.

KVAL P/N: **PERV5060**



Collet, 3/8", Perske 3 HP VS 50-60 Motor.

KVAL P/N: **PERV5060-3/8**



Collet Nut, Perske VS 50.11-2 Motor & 3 HP Motor.

KVAL P/N: **PERV5060N**

Torque Wrench



Torque Wrench for the ER40 Nut on the High Freq Colombo Motor

KVAL P/N: **COLTW300**



Collet Key Required to Use With the Torque Wrench for the ER 40 Collet Nut on the High Freq Colombo Motor (Collet Key 63S)

KVAL P/N: **COLKEY63S**

T-Handle



T-Handle, Hex Wrench, 5/16" X 9"

KVAL P/N: **MC5374A59**



T-Handle, Short-Length Hex Key 4 mm Hex, 2-1/2"

KVAL P/N: **MC7041A44**



T-Handle, Hex Wrench, 3/32 X 9

KVAL P/N: **THHW0609**



T-Handle, Hex Wrench, 1/8" X 3"

KVAL P/N: **THHW0803**

Screwdriver Chucks



Fastener, Internal Snap Ring,
Used With KVAL Chuck #28 & #32

KVAL P/N: **KVASC0098**

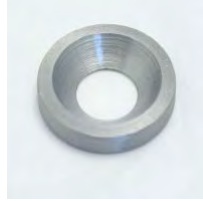

Retainer -- Tapered Chucks
(SC0028 and SC0032)

KVAL P/N: **KVASC0099**



Chuck 3/4 Sleeve 3/8 Bore

KVAL P/N: **KVASC01**



Chuck 1/2 Bore 3/4 Sleeve.

KVAL P/N: **KVASC03**



Chuck Sleeve Knurled 3/4"

KVAL P/N: **KVASC05**



Chuck Spring-.032 Music Wire 5/8-
Dia 5/8-Long Closed Ends.

KVAL P/N: **KVASC07**



Chuck Ball .156-Dia

KVAL P/N: **KVASC08**



Retaining Clip for SC Chucks
9/64 Dia

KVAL P/N: **KVASC09**

Tool Holder



Tooling, Tool Changer, Fork

KVAL P/N: **142-00-VE**



Magnetic Bit Holder, For 1/4" Hex
Phillips

KVAL P/N: **APEM490**



Tool Holder, HSK-63-F/ER40 Collet
Chuck

KVAL P/N: **COLHSK63F/ER40**



Bench Mount Tool Holder Tightening
Stand for 63MM OD Tool Holders.

KVAL P/N: **COLVE340**



Rebo Clamping Group - HSK-F 63
With Diffuser

KVAL P/N: **REBO-HSK-F63-D**



ISO-30 Plastic Holder For
A6161H0824 Spindle

KVAL P/N: **A7501A9300**

To see our full line of products,

go to kvalinc.com and type in

Tool Holder

Find



Cutter Head Blades



Cutter Blade, 30 MM Replacement Insert Blades for 140002.03 and 517708 Stack Cutter head, (Sold in Packs of 10)

KVAL P/N: **FOR140620**



Cutter Blade, 12MM X 25MM X 1.5MM, C4 Micro Grain Carbide, Reversible. (Price Per Pack of 10).

KVAL P/N: **FSKNIFE1225**



Cutter Blade, 14MM X 14MM X 2.0MM, CSK to suit 5MM Flat Head Screw, C4 Micro Grain Carbide, Scoring Blade. (Price Per Pack of 10).

KVAL P/N: **FSKNIFE14**



Cutter Blade, 50MM X 12MM X 1.5MM, C4 Micro Grain Carbide, Reversible. (Price Per Pack of 10).

KVAL P/N: **FSKNIFE50**



Cutter Blade, 60MM X 12MM X 1.5MM, C4 Micro Grain Carbide, Reversible. (Priced Per Pack of Ten)

KVAL P/N: **FSKNIFE60**



Cutter Blade, 7.5MM X 12MM X 1.5MM, Two Sided 1 Hole Carbide Insert, C4 Micro Grain, Box of 10

KVAL P/N: **FSKNIFE7.5**

Sanding Belts



Sanding Belt 3" X 36", 80-Grit Norzon R811

KVAL P/N: **NZBQ81181**



Sanding Belt 3" X 36", 100-Grit Norzon R811

KVAL P/N: **NZBQ81182**

Cutter Head & Supplies



Tooling, GIB Screw, M6-1.00 X 16 AL-Head for the 60mm Head 121-

KVAL P/N: **CAR1200028**



Tooling, 60mm Cutter head for 555 Machines

KVAL P/N: **CAR121254**



Tooling, 60mm GIBS for the 60mm Cutter Head 121-254

KVAL P/N: **CAR121254-G**



Set Screw, 5/16-24 X 1/2 FP Set Screw For the 60MM Cutter Head 121-254

KVAL P/N: **CAR121254-S**



Saw Blades



Saw Blade, 12" Standard 60 Tooth Saw Blade with 3/4 Bushing.

KVAL P/N: AC3260



Saw Blade, 8" X 60 Tooth Cross Cut Saw Blade ATB 1" Arbor

KVAL P/N: FOR66148M



Spline Saw Blade 2-1/2 Dia. 7/16-ID, 44 Tooth, (Used With Kvarbor16B)

KVAL P/N: KVA203610



Saw Blade, 10" X 60 Tooth X 5/8" Arbor, ATB

KVAL P/N: SB106010



Saw Blade, 10" X 80 Tooth X 5/8" Arbor, ATB

KVAL P/N: SB108010



Saw Blade, 12" X 60 Tooth X 1" Bore (.118 Tooth Width)

KVAL P/N: SB126016



Saw Blade, 12" X 80 Tooth X 1" Bore, Pro 300 X 3.0 X 2.45 X A-15

KVAL P/N: SB128016



Saw Blade, 12" X 96 Tooth X 1" Bore

KVAL P/N: SB129616



Saw Blade, 12" X 96 Tooth X 1-1/8" Arbor

KVAL P/N: SB129618



Saw Blade, 14" X 108 Tooth X 1" Arbor

KVAL P/N: SB1410816



Saw Blade, 9" X 40 Tooth Budke Saw Blade With 3/4 Arbor Hole

KVAL P/N: SYS1020M



Saw Blade, 10" X 80 Tooth X 3/4" Arbor Trim Saw Blade 6 Deg Negative Hook #1245

KVAL P/N: SYS1245M

Screw Driving Parts—6 Shooter



6 Shooter Left Side Guide, Brass 3/16 X 1-1/4 X 1-3/4.

KVAL P/N: 13-00-QL

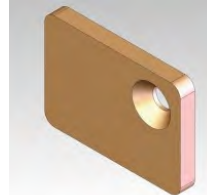

6 Shooter Right Side Guide, Brass 3/16 X 1-1/4 X 1-3/4.

KVAL P/N: 13-00-QR



6 Shooter, Screw Receiver Block with Setscrews Only.

KVAL P/N: 990F3902SRB

To see our full line of products,

go to kvalinc.com and type in

Chucks

Find



Funnel Tube Adapter for Air Injection.

KVAL P/N: FUNLTUBE8



Funnel Tube Style-3 (1-1/2 Long)

KVAL P/N: FUNLTUBE7



Rubber Ring, Large 1/2-ID 3/4-OD X 1/8" Urethane Tubing

KVAL P/N: KVARR02



Chuck 3/4" Sleeve 3/8" Bore

KVAL P/N: KVASC01



Chuck Sleeve Knurled 3/4"

KVAL P/N: KVASC05



Chuck Spring-.032 Music Wire 5/8-Dia 5/8-Long Closed Ends.

KVAL P/N: KVASC07



Chuck Ball .156-Dia

KVAL P/N: KVASC08



Retaining Clip for SC Chucks 9/64 Dia.

KVAL P/N: KVASC09



Spring 19/32-ID X 1-1/16 Long, .062 Wire 6 Coils Ground Ends

KVAL P/N: KVASPR02

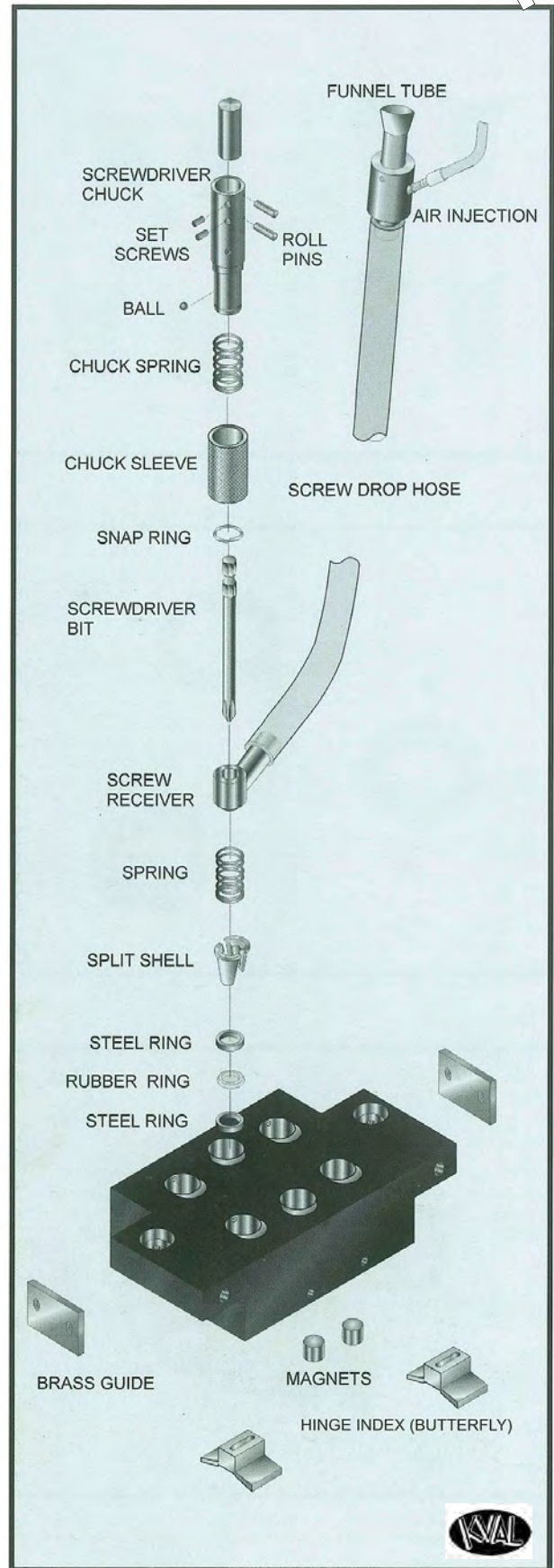



Screw Driving Parts—6 Shooter



Split Shell 77 Large
KVAL P/N: **KVASPS77L**



Steel Ring .650 ID X .875 OD X .125 Thick.
KVAL P/N: **KVASR01.650**



Screw Receiver 01LG External with Extended Barrel 23/64-ID (990FA, 990FX, 990F3 & F4) **Substitute for: KVAX76LX**
KVAL P/N: **KVAX01LX**



Screw Receiver 01LG Long Tube External with Extended Barrel 23/64-ID (990FA, 990FX, 990F3 & F4) **Substitute for: KVAX76LXL**
KVAL P/N: **KVAX01LXL**



Parflex,E-108 ,1/2-ID 5/8-OD .062 Wall Natural Poly Tube
KVAL P/N: **PARE108**



Magnet, PM 090-2, 1/2" Dia. X 5/8" Long
KVAL P/N: **PERPM0902**



Screw Driving Parts—727 & 737



Rubber Ring, Large 1/2"-ID 3/4"-OD X 1/8" Urethane Tubing
KVAL P/N: **KVARR02**



Chuck 1/2" Bore 3/4" Sleeve.
KVAL P/N: **KVASC03**



Chuck Sleeve Knurled 3/4".
KVAL P/N: **KVASC05**



Chuck Spring-.032 Music Wire 5/8"-Dia 5/8"-Long Closed Ends.
KVAL P/N: **KVASC07**



Chuck Ball .156-Dia
KVAL P/N: **KVASC08**



Retaining Clip for SC Chucks 9/64" Dia.
KVAL P/N: **KVASC09**



Spring 19/32"-ID X 1-1/16" Long,
.062 Wire 6 Coils Ground Ends

KVAL P/N: **KVASPR02**



Split Shell 77 Large

KVAL P/N: **KVASPS77L**



Steel Ring .650" ID X .875" OD
X .125 Thick.

KVAL P/N: **KVASR01.650**



Screw Receiver 01LG 23/64-ID
External With Extended Barrel
Substitute for : **KVAX76LX**

KVAL P/N: **KVAX01LX**



Parflex,E-108 ,1/2"-ID 5/8-
OD .062" Wall Natural Poly Tube

KVAL P/N: **PARE108**



SPECIFY HINGE PATTERN

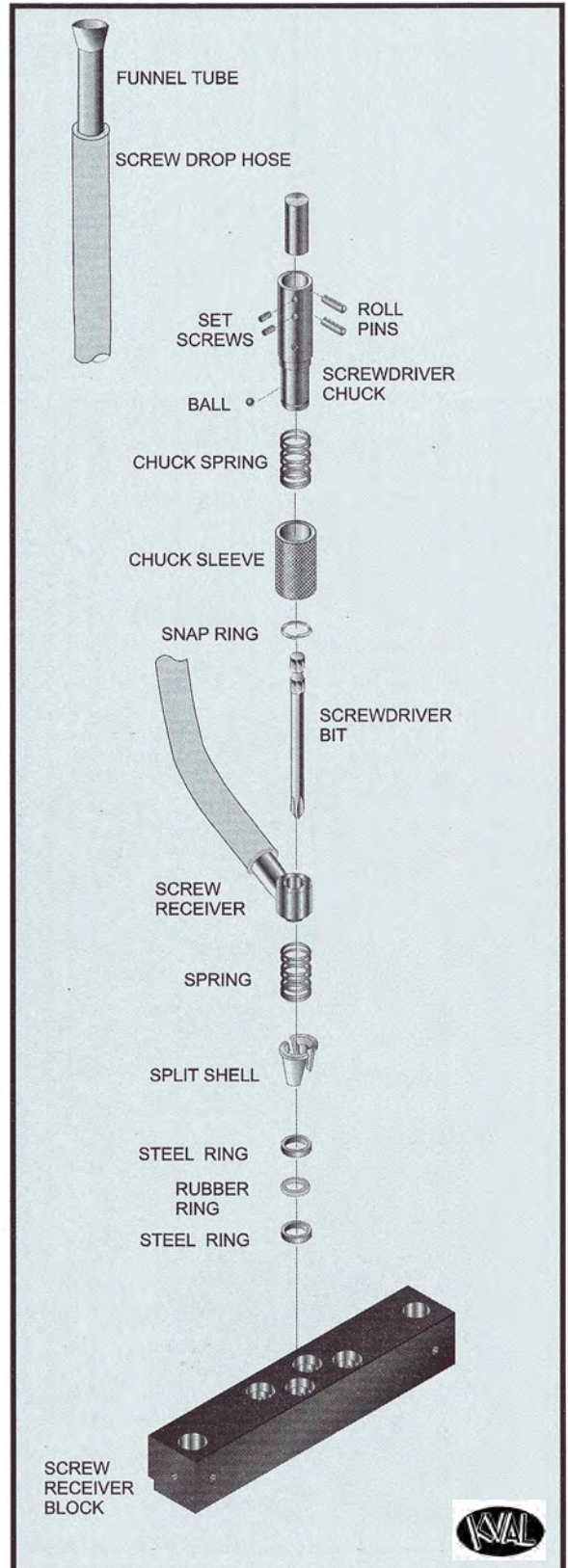



Screw Driving Parts—777-B Style 2



Rubber Ring, Large 1/2"-ID 3/4"-OD X 1/8" Urethane Tubing

KVAL P/N: KVARR02



Chuck 1/2" Bore 3/4" Sleeve.

KVAL P/N: KVASC03



Chuck Sleeve Knurled 3/4".

KVAL P/N: KVASC05



Chuck Spring-.032 Music Wire 5/8-Dia 5/8-Long Closed Ends.

KVAL P/N: KVASC07



Chuck Ball .156-Dia

KVAL P/N: KVASC08



Retaining Clip for SC Chucks 9/64" Dia.

KVAL P/N: KVASC09

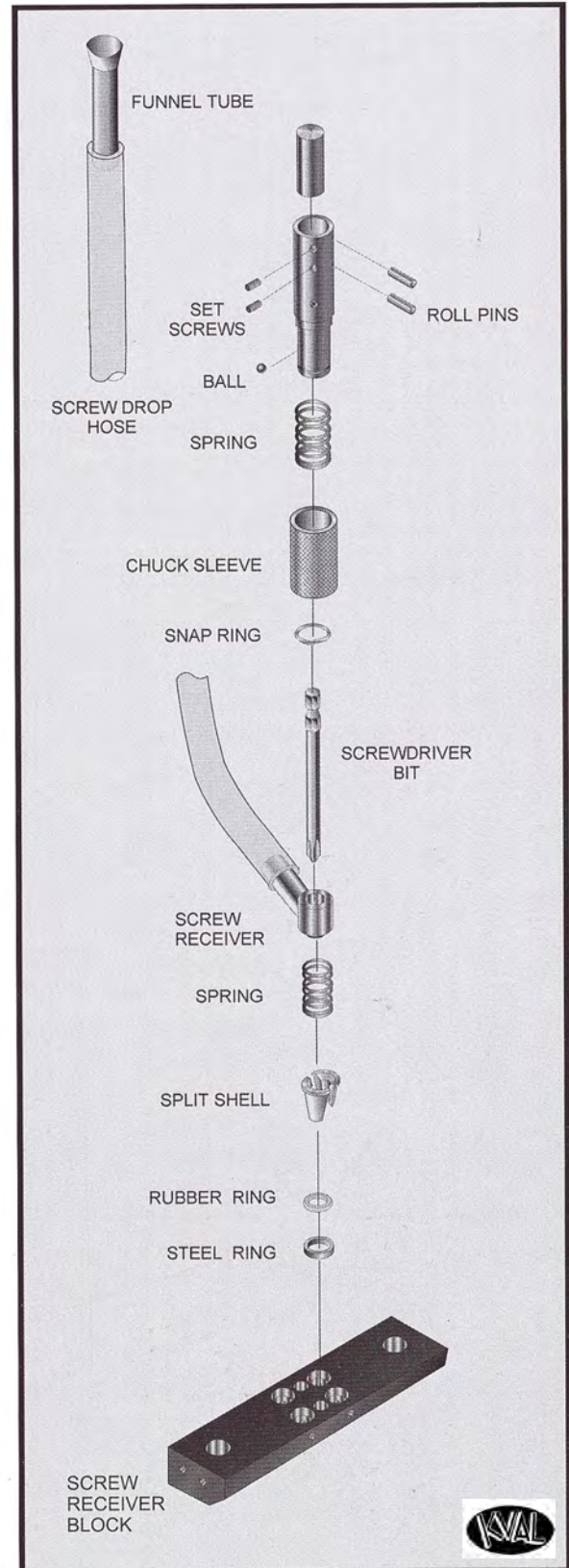

To see our full line of products,

go to kvalinc.com and type in

777

Find



Spring 19/32"-ID X 1-1/16" Long, .062 Wire 6 Coils Ground Ends

KVAL P/N: **KVASPR02**

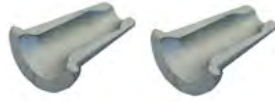

Split Shell 75 Large

KVAL P/N: **KVASPS75L**



Steel Ring .650" ID X .875" OD X .125 Thick.

KVAL P/N: **KVASR01.650**



Screw Receiver '76 Medium External 23/64"-ID

KVAL P/N: **KVAX76MX**



Parflex,E-108 ,1/2-ID 5/8-OD .062 Wall Natural Poly Tube

KVAL P/N: **PARE108**



SPECIFY HINGE PATTERN

Screw Driving Parts—777-C Style 3



Rubber Ring, Large 1/2"-ID 3/4"-OD X 1/8" Urethane Tubing

KVAL P/N: **KVARR02**



Chuck 1/2" Bore 3/4" Sleeve.

KVAL P/N: **KVASC03**



Chuck Sleeve Knurled 3/4"

KVAL P/N: **KVASC05**



Chuck Spring-.032 Music Wire 5/8"-Dia 5/8"-Long Closed Ends.

KVAL P/N: **KVASC07**



Chuck Ball .156-Dia

KVAL P/N: **KVASC08**



Retaining Clip for SC Chucks 9/64" Dia.

KVAL P/N: **KVASC09**



Spring 19/32"-ID X 1-1/16" Long, .062 Wire 6 Coils Ground Ends

KVAL P/N: **KVASPR02**

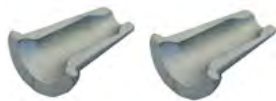

Split Shell 75 Large

KVAL P/N: **KVASPS75L**

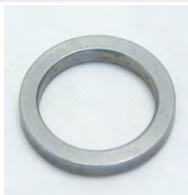

Steel Ring .650" ID X .875" OD X .125 Thick.

KVAL P/N: **KVASR01.650**



Screw Receiver '76 Medium External 23/64"-ID

KVAL P/N: **KVAX76MX**



Parflex, E-108, 1/2"-ID 5/8-OD .062" Wall Natural Poly Tube

KVAL P/N: **PARE108**



Mfg, 777, Hinge Flip Door Divider Left, .062 Blade Thickness

KVAL P/N: **76-00-DF-0L**



Mfg, 777, Hinge Flip Door Divider Right, .062 Blade Thickness

KVAL P/N: **76-00-DF-0R**

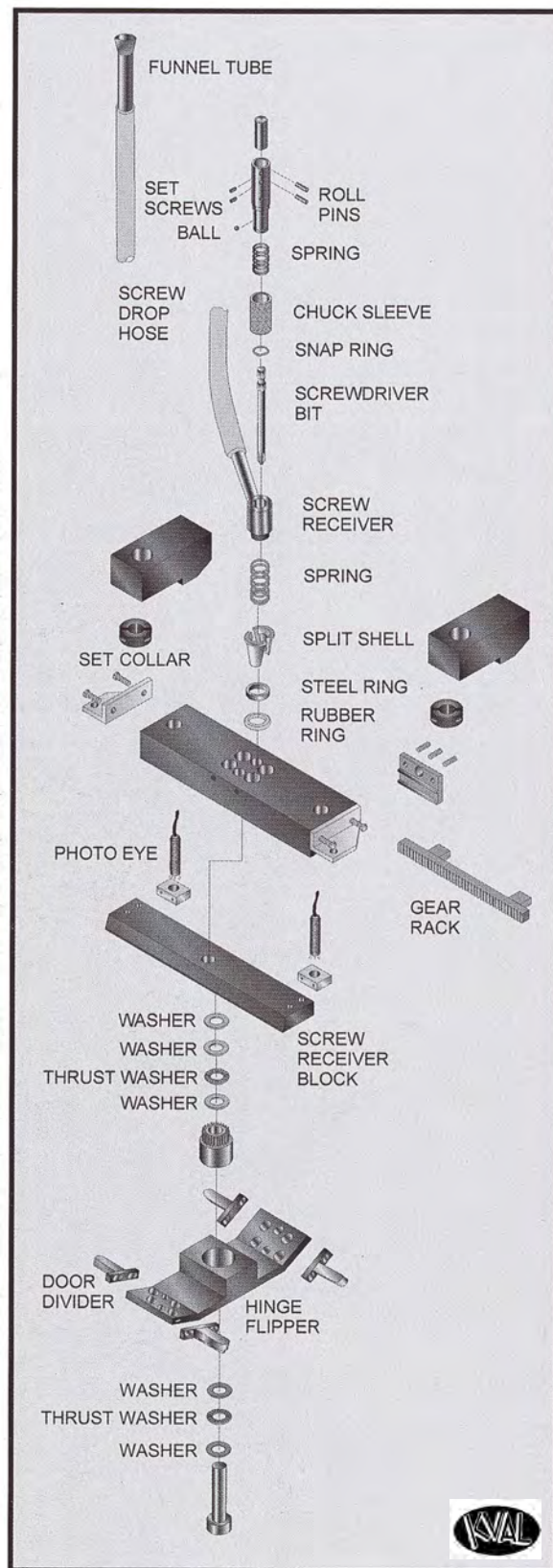

Screw Driving Parts—888

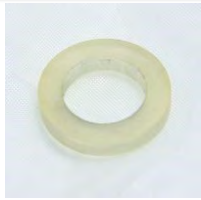

Rubber Ring, Large 1/2-ID 3/4-OD X 1/8 Urethane Tubing (6 Shooter)

KVAL P/N: **KVARR02**



Chuck 1/2" Bore 3/4" Sleeve.

KVAL P/N: **KVASC03**



Chuck Sleeve Knurled 3/4"

KVAL P/N: **KVASC05**



Chuck Spring-.032 Music Wire 5/8-Dia 5/8-Long Closed Ends.

KVAL P/N: **KVASC07**



Chuck Ball .156-Dia

KVAL P/N: **KVASC08**



Retaining Clip for SC Chucks 9/64" Dia.

KVAL P/N: **KVASC09**

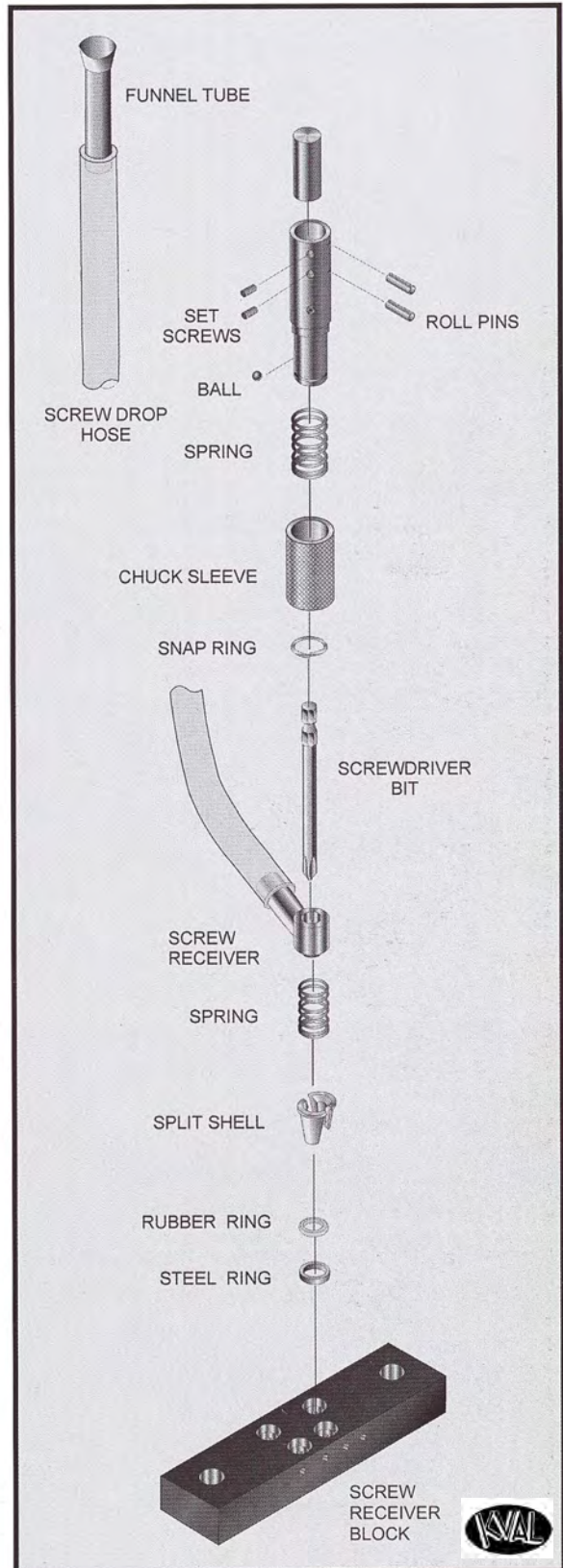



Screw Driving Parts—888



Spring 1/2-ID X 1-1/16 Long, 74' Series, .052 Wire 6-Coils Ground Ends

KVAL P/N: **KVASPR01**



Split Shell 74 Small

KVAL P/N: **KVASPS74S**



Steel Ring .650" ID X .875" OD X .125 Thick.

KVAL P/N: **KVASR01.650**



Screw Receiver '76 Small 5/16"-ID

KVAL P/N: **KVAX76S**



Parflex, E-86, 3/8"-ID 1/2"-OD 062 Wall Natural Poly Tube

KVAL P/N: **PARE086N**



Screw Receiver Mastercraft Outer Left & Right 5/16 ID

KVAL P/N: **KVAXCDMC1**



Screw Driving Parts—980



Rubber Ring, Large 1/2"-ID 3/4"-OD X 1/8" Urethane Tubing

KVAL P/N: **KVARR02**



Chuck 1/2" Bore 3/4" Sleeve.

KVAL P/N: **KVASC03**



Chuck Sleeve Knurled 3/4".

KVAL P/N: **KVASC05**



Chuck Spring-.032 Music Wire 5/8"-Dia 5/8"-Long Closed Ends.

KVAL P/N: **KVASC07**



Chuck Ball .156-Dia

KVAL P/N: **KVASC08**



Retaining Clip for SC Chucks 9/64" Dia.

KVAL P/N: **KVASC09**



Spring, 1/2"-ID X 1-1/16" Long, 74 Series .052 Wire, 6 Coils Ground Ends

KVAL P/N: **KVASPR01**



Split Shell 74 Small

KVAL P/N: **KVASPS74S**



Steel Ring .650" ID X .875" OD X .125 Thick.

KVAL P/N: **KVASR01.650**



Screw Receiver '76 Small 5/16"-ID

KVAL P/N: **KVAX76S**



Parflex, E-86, 3/8"-ID 1/2"-OD 062 Wall Natural Poly Tube

KVAL P/N: **PARE086N**



Screw Receiver Mastercraft Outer Left & Right 5/16 ID

KVAL P/N: **KVAXCDMC1**

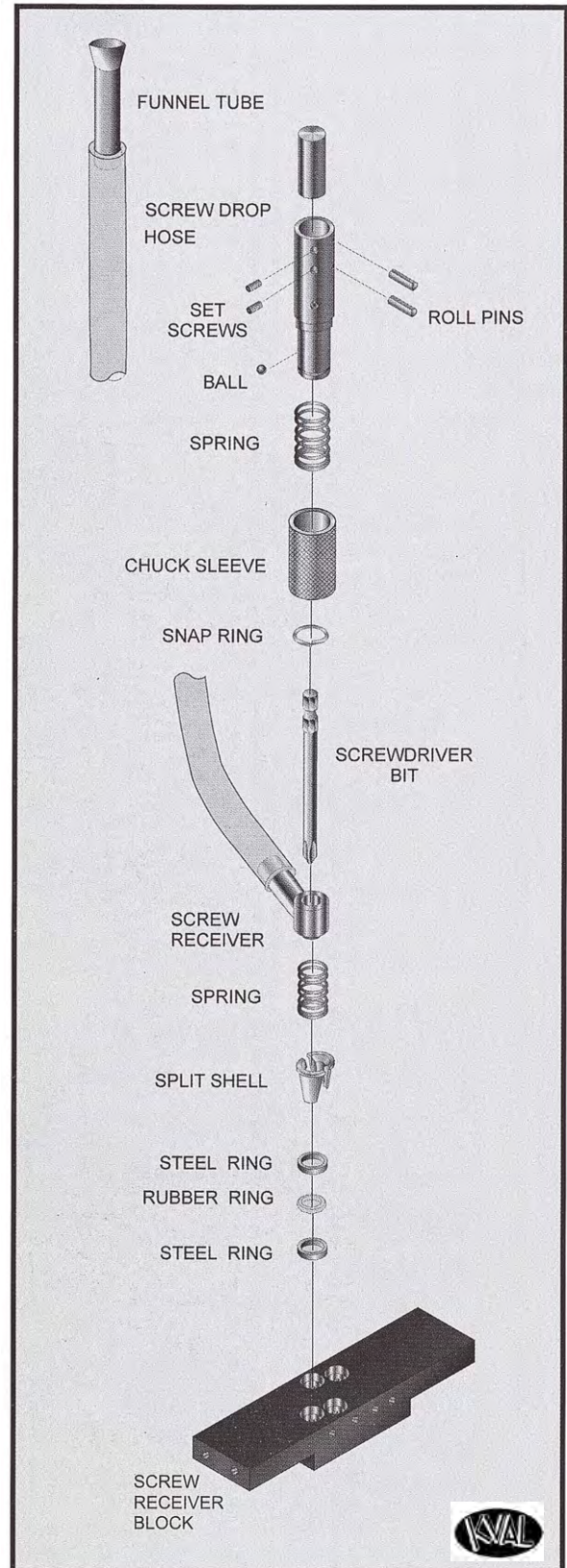



Screw Driving Parts—BF-3



Bit, Phillips 1/4 X 3-1/2" OAL
2 Philips Head

KVAL P/N: KVAL492BI



Spring 1/2-ID X 1-1/16 Long, 74'
Series, .052 Wire 6-Coils Ground
Ends

KVAL P/N: KVASPR02



Split Shell 74 Small

KVAL P/N: KVASPS74S

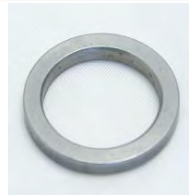

Steel Ring .650" ID X .875" OD
X .125 Thick.

KVAL P/N: KVASR01.650



Magnet, 5U-31B, 5/8" Dia. 5/8"
Long

KVAL P/N: PER5U31B

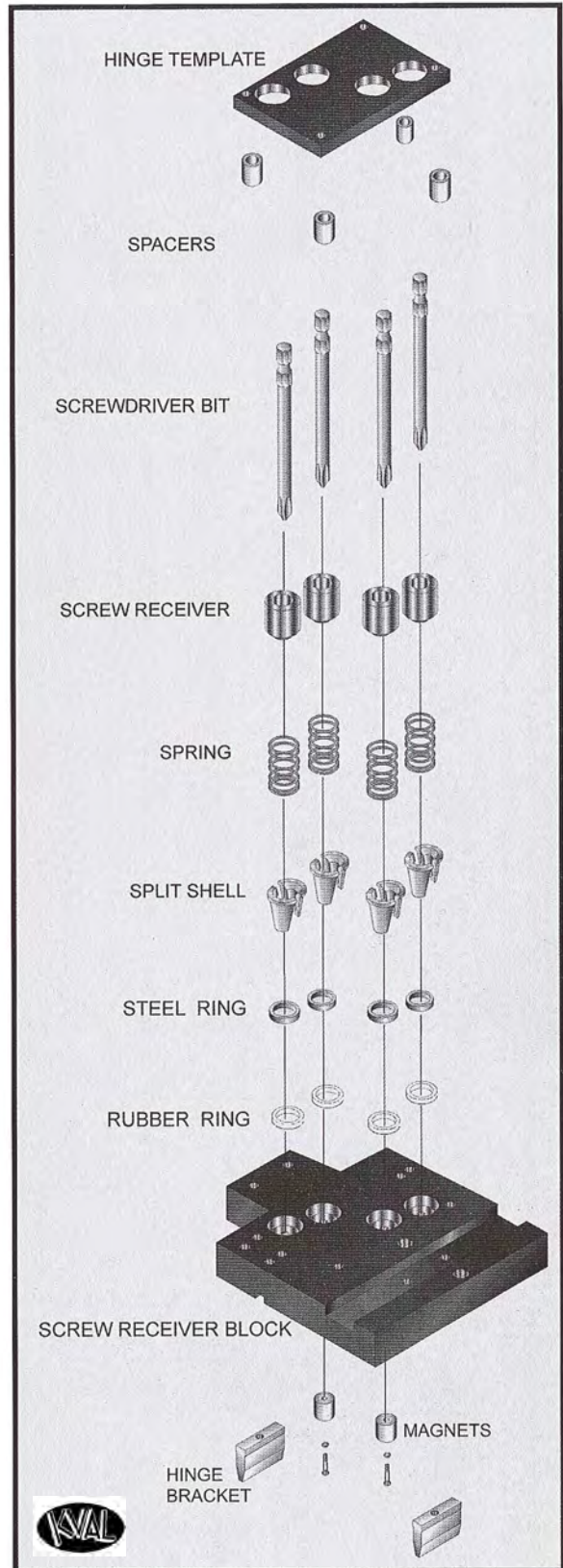

Screw Driving Parts—CD-10



Chuck 3/4" Sleeve 3/8" Bore

KVAL P/N: KVASC01



Chuck Spring-.032 Music Wire 5/8-Dia 5/8-Long Closed Ends.

KVAL P/N: KVASC07



Chuck Ball .156-Dia

KVAL P/N: KVASC08



Retaining Clip for SC Chucks 9/64" Dia.

KVAL P/N: KVASC09



Parflex, E-86, 3/8"-ID 1/2"-OD 062 Wall Natural Poly Tube

KVAL P/N: PARE086N



Magnet, PM 090-2, 1/2" Dia. X 5/8" Long

KVAL P/N: PERPM0902

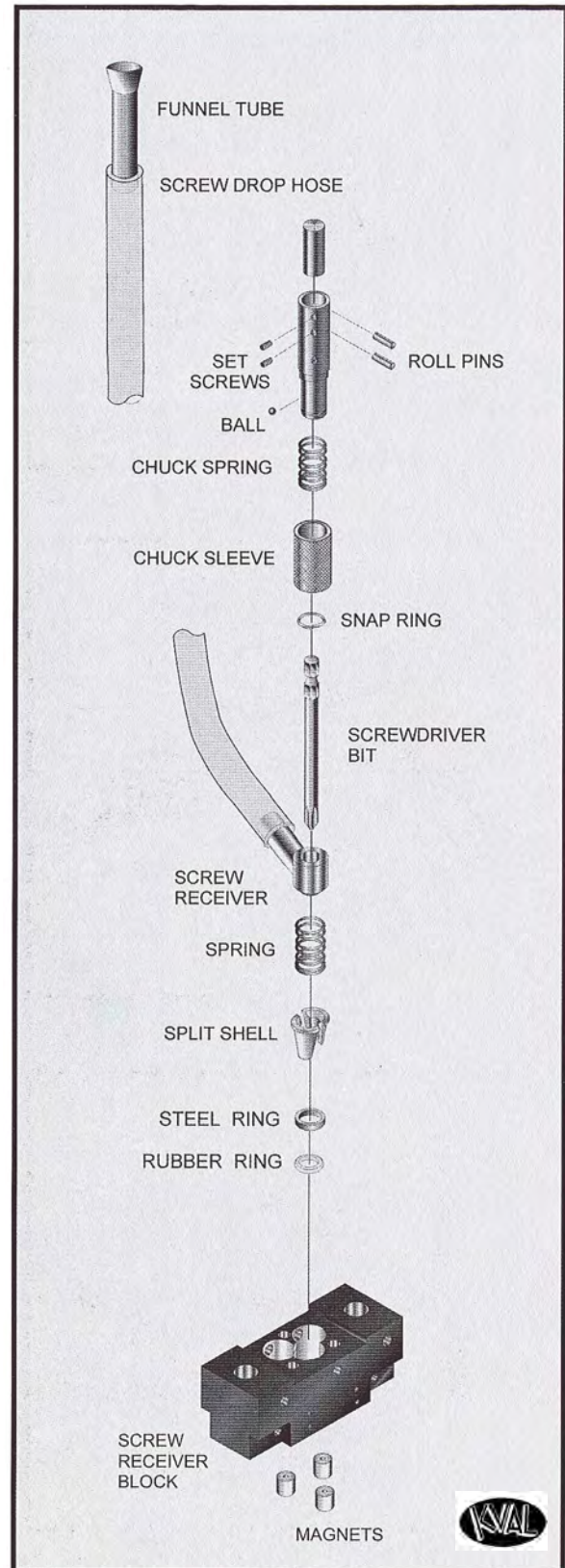



Screw Driving Parts— 8 Shooter



Funnel Tube Adapter for Air Injection.

KVAL P/N: FUNLTUBE8



Funnel Tube Style-3 (1-1/2 Long)

KVAL P/N: FUNLTUBE7



Rubber Ring, Large 1/2"-ID 3/4"-OD X 1/8" Urethane Tubing

KVAL P/N: KVARR02



Chuck 3/4" Sleeve 3/8" Bore

KVAL P/N: KVASC01



Chuck Sleeve Knurled 3/4"

KVAL P/N: KVASC05



Chuck Spring-.032 Music Wire 5/8-Dia 5/8-Long Closed Ends.

KVAL P/N: KVASC07

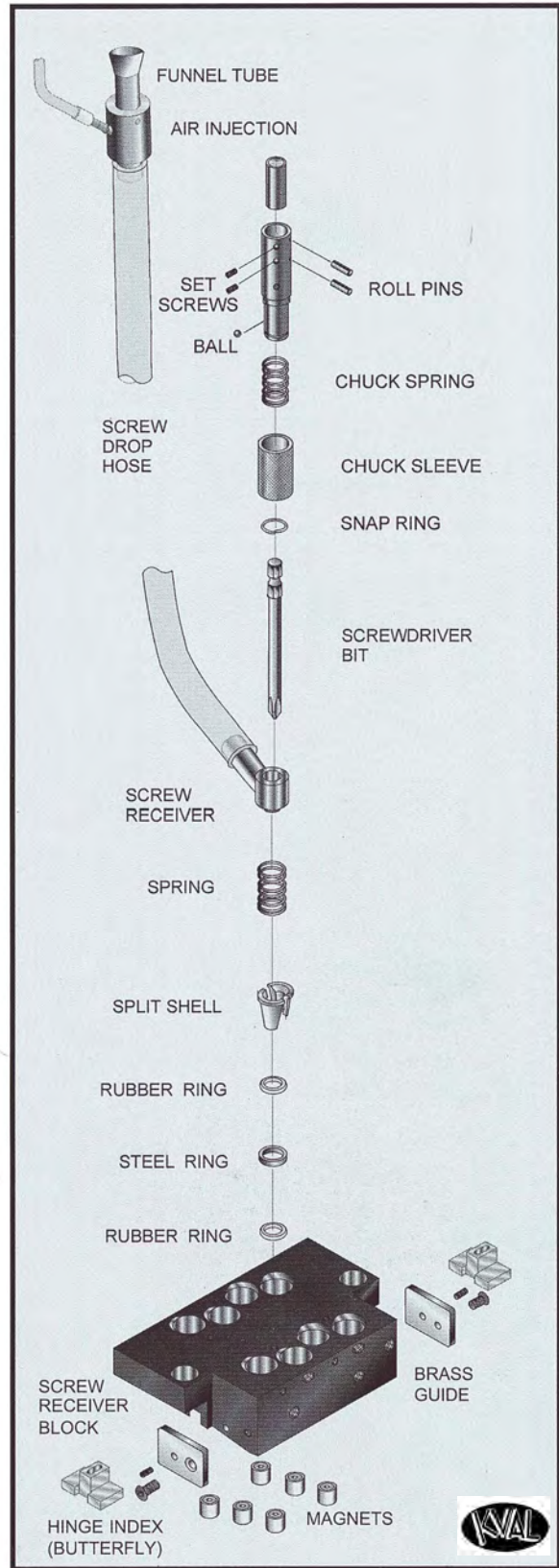

To see our full line of products,

go to kvalinc.com and type in

Funnel Tubes

Find



Chuck Ball .156-Dia

KVAL P/N: **KVASC08**



Retaining Clip for SC Chucks 9/64 Dia.

KVAL P/N: **KVASC09**



Spring 19/32-ID X 1-1/16 Long, .062 Wire 6 Coils Ground Ends

KVAL P/N: **KVASPR02**



Split Shell 77 Large

KVAL P/N: **KVASPS77L**



Steel Ring .650 ID X .875 OD X .125 Thick.

KVAL P/N: **KVASR01.650**



Screw Receiver '76 Large External 25/64-ID

KVAL P/N: **KVAX76LX**



Screw Receiver 76 Large Long External 25/64-ID

KVAL P/N: **KVAX76LXL**



Parflex,E-108, 1/2-ID 5/8-OD .062 Wall Natural Poly Tube

KVAL P/N: **PARE108**



Magnet, PM 090-2, 1/2" Dia. X 5/8" Long

KVAL P/N: **PERPM0902**



Split Shell 77 X-Large
(Used With #10 Screws Only)

KVAL P/N: **KVASPS77X**

Funnel Tubes



Hopper, OPT A, Main, Screw Tube, Hydraulic Tube, 1/2 OD X 7/16 ID X 5.

KVAL P/N: **27-0A-XA**



Funnel Tube Style-3 (1-1/2 Long)

KVAL P/N: **FUNLTUBE7**



Funnel Tube Adapter for Air Injection.

KVAL P/N: **FUNLTUBE8**



Funnel Tube, Large Style-3, 4-7/8 Straight Funnel 1/2 O.D. X 7/16 I.D. X 3-5/8 Long

KVAL P/N: **FUNLTUBE9**



Funnel Tube, Large Style, 5/8
Funnel X 2" Long, 1/2 O.D. X
7/16 I.D. X 2" OAL.

KVAL P/N: FUNLTUBE10

Steel Rings



Steel Ring .650 ID X .875 OD X .125
Thick.(6 Shooter)

KVAL P/N: KVASR01.650



Steel Ring .715 ID X .875 OD X .125
Thick. (8 Shooter # 10 Screws Only)

KVAL P/N: KVASR01.715

Rubber Rings



Rubber Ring, Large 1/2-ID 3/4-OD
X 1/8" Urethane Tubing

KVAL P/N: KVARR02

Magnets



PM 090-2 MAGNET 1/2 DIA X 5/8
LONG (6 Shooter Magnet)

KVAL P/N: PERPM0902

Screw Feeder Drop Hose



Parflex,E-108 ,1/2-ID 5/8-OD .062
Wall Natural Poly Tube

KVAL P/N: PARE108



Natural Parflex 11/64 ID .40 Wall
1/4 OD Clear Tube, 1 Box (500 Ft)

KVAL P/N: PARE43500



PVC Hose for Screw Drop, Sold In 100
FT Rolls Only, 1/2-ID 5/8-OD .062 Wall
(PARE108 Softer Material, Only for
Specific Applications.)

KVAL P/N: HOSE625500

To see our full line of products,

go to kvalinc.com and type in

Screw Receivers

Find



Screw Receivers



Screw Receiver 01 Long 25/64"-ID External with Extended Barrel

KVAL P/N: KVAX01LX



Screw Receiver 01 Long Tube 23/64"-ID External with Extended Barrel

KVAL P/N: KVAX01LXL



LH Screw Receiver 01Series Large- Long Tube 25/64"-ID Ext with Extended Barrel

KVAL P/N: KVAX01LXL-LH



RH Screw Receiver 01Series Large- Long Tube 25/64"-ID Ext with Extended Barrel

KVAL P/N: KVAX01LXL-RH



Screw Receiver '76 Small 5/16-ID

KVAL P/N: KVAX76S



Screw Receiver '76 Large External 25/64"-ID

KVAL P/N: KVAX76LX



Screw Receiver '76 Medium External 23/64"-ID

KVAL P/N: KVAX76MX



Screw Receiver Master craft Outer - Left and Right 5/16"-ID.

KVAL P/N: KVAXCDMC1

Split Shells



Split Shell 74 Small (888 & BF-3)

KVAL P/N: KVASPS74S

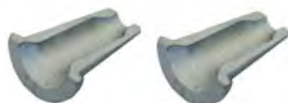

Split Shell 75 Large (777)

KVAL P/N: KVASPS75L



Split Shell 77 Large (6 Shooter)

KVAL P/N: KVASPS77L

Split Shells Springs



Spring 1/2-ID X 1-1/16 Long, .052 Wire 6-Coils Ground Ends

KVAL P/N: KVASPR01



Spring 19/32-ID X 1-1/16 Long, .062 Wire 6 Coils Ground Ends

KVAL P/N: KVASPR02



Spring 19/32-ID X 7/8 Long, .062 Wire 5 Coils Ground Ends

KVAL P/N: KVASPR03



Collet Wrench



Collet Wrench, ER20-E, For Colombo 1.5 HP Hi-Frequency Motor

KVAL P/N: COLER20-CW



Collet Wrench, ER25-M Finger, For Colombo 3 HP Hi-Frequency Motor

KVAL P/N: COLER25-CW



Collet Wrench, ER25, For Colombo 7.5 HP Hi-Frequency Motor

KVAL P/N: COLER25-CW7



Collet Wrench, ER40, For Colombo 11 HP Hi-Frequency Motor, SYIC-04617

KVAL P/N: COLER40-CW



Collet Wrench, ER16 Series, 3/8" Collet, 2 HP Perske (Fingers)

KVAL P/N: PERER16W



Collet Wrench, ER20 Series, 1/2" Collet, 1 and 2 HP Perske (Fingers)

KVAL P/N: PERER20W

Combo Wrench



Shaft Wrench, Open End, 18MM, For Colombo High Frequency Motor

KVAL P/N: WRENCH18MM

Pump Wrench



Pump Wrench, 1-1/4 Thin Pattern, 1240

KVAL P/N: WRENCH020



Pump Wrench, 1-5/8" Thin Pattern

KVAL P/N: WRENCH026



Pump Wrench, 1-3/4 Thin Pattern, 1256

KVAL P/N: WRENCH028



Pump Wrench, 1-13/16 Thin Pattern

KVAL P/N: WRENCH029

To see our full line of products,

go to kvalinc.com and type in

Shaft wrench

Find



Pump Wrench, 1-7/8 Thin Pattern, 1260

KVAL P/N: WRENCH030



Pump Wrench, 2" Thin Pattern, 1264

KVAL P/N: WRENCH032



Pump Wrench, 2-1/4" Thin Pattern, 1272

KVAL P/N: WRENCH036

Shaft Wrench



Wrench, 36MM, Open End, For Ekstrom- Carlson & RH Saw Motors on KVAL 979-2

KVAL P/N: WRENCH036MM



Wrench, 41MM, Open End, For Perske Hi-Frequency Motor PERKRSV61.13-2D

KVAL P/N: WRENCH041M



Wrench, 46MM, Open End, For Perske PERKCS70122LH & RH Saw Motors on KVAL 979-2

KVAL P/N: WRENCH046MM



Shaft Wrench, 16MM, Open End, For Bosch 1617 Router Motor

KVAL P/N: WRENCH16MM



Shaft Wrench, 17MM, V30/40 Shaft .37 HP Perske.

KVAL P/N: WRENCH17MM



Shaft Wrench, 22MM, 1 and 2 HP Perske Motor and 1.5 hp Columbo motor With 1/2 Collet Capacity.

KVAL P/N: WRENCH22MM



Shaft Wrench, 24MM, 3 HP Perske and 3 HP Colombo Hi-Frequency

KVAL P/N: WRENCH24M



Shaft Wrench, 27MM, 7.5 HP Colombo Hi-Frequency Motor

KVAL P/N: WRENCH27MM

Spanner Wrench



Wrench for the Acuraflex Nut

KVAL P/N: 15-00-ER32



Spanner Wrench, 2" X 6 Long, 34-213

KVAL P/N: SPANNER34213



Spanner Wrench, N6 Nut (Martin 455)

KVAL P/N: SPANNERN6



Wrench, Colombo 10 HP High Frequency Motor

KVAL P/N: WRENCHER40

To see our full line of products,

go to kvalinc.com and type

Air Screwdriver

Find

Air Screwdrivers



Air Screwdriver, 1/4" Straight Internal Adjustable Screw Driver, 18000 RPM, 800T

KVAL P/N: DAY6Z665



Ingersoll Rand IR371 Air Screwdriver, Reversible with positive action clutch, Standard Duty

KVAL P/N: IR-371



Ingersoll Rand 5RLNC1 Air Screwdriver, Free speed 1000 RPM, Torque Range Soft Draw 13-75 Inch Pounds

KVAL P/N: IR3Y529

Sipp Gun



Sipp Model #65, Door Light Corner Squaring Chisel

KVAL P/N: SIP00065L



Sipp, 1/2" O Ring (#14), For Model #65

KVAL P/N: SIP00065L14



Sipp, Piston Seal (#20), For Model #65

KVAL P/N: SIP00065L20

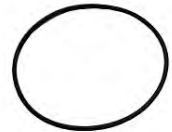

Sipp, O Ring 2-1/2" (#22), For Model #65

KVAL P/N: SIP00065L22



Sipp, Upper Piston Shaft Seal (#24), For Model #65

KVAL P/N: SIP00065L24



Sipp 70-H Corner Notcher - Hinge Chisel

KVAL P/N: SIP00070H



Sipp 70-L Corner Notcher - Latch Chisel

KVAL P/N: SIP00070L



Sipp 70-X Corner Notcher - Hinge Chisel, 5/8" Radius

KVAL P/N: SIP00070X



Sipp End Cap (#1)

KVAL P/N: SIP001



Sipp End Cap O Ring (#01A)

KVAL P/N: SIP001A



Sipp, Head Roll Pin

KVAL P/N: SIP002



Sipp, Return Spring, #3

KVAL P/N: SIP003



Sipp Hammer (#4)
KVAL P/N: SIP004



Sipp Socket Cap Screw 10-24 X 1-3/8 Flat Head, with Self Locking 10-24 Nut
KVAL P/N: SIP005



Sipp, 10-24 Self Locking Nut
KVAL P/N: SIP005A



Sipp, Back Head Plate, #6
KVAL P/N: SIP006



Sipp O Ring (#7)
KVAL P/N: SIP007



Sipp Body (#8) with Trigger Valve and End Cap
KVAL P/N: SIP008



Sipp Trigger Valve (#9)
KVAL P/N: SIP009



Sipp Head, Hinge Recess (#10)
KVAL P/N: SIP010H



Sipp Head, Latch Plate (#10)
KVAL P/N: SIP010L



Sipp Spring Retainer (#11)
KVAL P/N: SIP011



Sipp Socket Head Cap Screw 10-24 X 5/8
KVAL P/N: SIP012



Sipp Cutter Blade (#13)
KVAL P/N: SIP013



Sipp Head Spring Seat (#14)
KVAL P/N: SIP014



Sipp Head Compression Spring (#15)
KVAL P/N: SIP015



Sipp, End Cap Wrench, #16
KVAL P/N: SIP016



Sipp, 5/32 Allen Wrench
KVAL P/N: SIP017

To see our full line of products,

go to kvalinc.com and type

Sipp

Find



Sipp, Phenolic Cover For Base Plate
KVAL P/N: SIP027



Cutter for the Model #65 Corner Square (Cutter #114).
KVAL P/N: SIP038



Tooling ,SIPP, Cutter for the Model #65X Corner Square (CS-38X)
KVAL P/N: SIP038X



Sipp Socket Head Cap Screw 10-24 X 1/2, Grade 8
KVAL P/N: SIP039

Staple Guns Holder

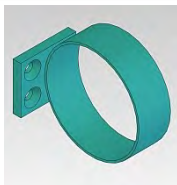

Screw Gun Holder Mount Assembly, Includes spiral wrap encasement & (2) 1/4-20 X 5/8 LG FH
KVAL P/N: 536A

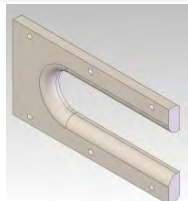

Staple Gun Protector
KVAL P/N: 542C

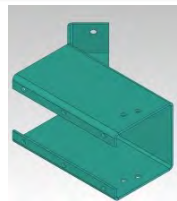

Staple Gun Holder Mount Bracket.
KVAL P/N: 543C-0

Tool Balancer



Tool Balancer, 2-4 lbs, 4" Dia., 2" Deep
KVAL P/N: AER6W200

Demagnetizer



Demagnetizer, KBC, 8-604-002, Table Size: 6-3/4" x 4-1/2"
KVAL P/N: KBC8604002

Slotting Cutter



Router Bit, 3 Wing Slotting Cutter, 1/4 Kerf, 1-7/8" Dia., 5/16" Bore
KVAL P/N: AMA53210

KVAL Apparel



KVAL Tee-Shirt, Black, Short Sleeved.
KVAL P/N: KVALTSM



KVAL FlexFit Hat with logo, Black, Embroidered Logo
KVAL P/N: KVALHATS



KVAL Mug with Logo, Black
KVAL P/N: KVALMUG



KVAL Black Sweatshirt, Embroidered Logo
KVAL P/N: KVALSWEATSH



Making Quality Door and Jamb Machinery Since 1947

INNOVATION | QUALITY | HONESTY

Order Today!
Call 1.800.553.5825

Notes



Making Quality Door and Jamb Machinery Since 1947

INNOVATION | QUALITY | HONESTY

Order Today!
Call 1.800.553.5825

Notes



Making Quality Door and Jamb Machinery Since 1947

INNOVATION | QUALITY | HONESTY

Order Today!
Call 1.800.553.5825

Notes

Table of Content

Pages

A

Adhesive	83
Advance - Clevis & Mounting Brackets - 120 Series	17
Advance - Clevis & Mounting Brackets - 240 Series	17
Advance - Clevis & Mounting Brackets - 300 Series	17
Advance - Clevis & Mounting Brackets - 490 Series	17
Advance - Cylinder Repair Kit	19
Advance - Double Cushion 120 Series	20
Advance - Double Cushion 240 Series	20
Advance - Double Cushion 490 Series	20
Advance - Double Rod Ends	20
Advance - Hydraulic Series	21
Advance - I Series Series	24
Advance - Rear Cushions Series	22
Advance - Standard Series (120,240,300,490,700,960 & 1600)	22,23,24
Advance - Style 3 Series	24
Air Filter	89
Air Hose	15
Air Motor	14
Air Pushbuttons & Switches	16
Air Screwdriver	198,199,200
Akro Bin	83
Arbors for Spin-On Bits	156,157
Auxiliary Contact	50

B

Ball & Spring Plunger	85
Ball Nut Screw	120
Bearing Block	126
Bimba - Mounting Accessories	35
Bimba - Repair Kit	38
Bimba Cylinders	29-34
Bimba Position Sensing Switches	70
Beckhoff Componets	58-60
Blow-Off	16
Bosch Router	65
Branch Tee	8
Brass Hex Nipples	6
Brass Nipples	6
Brass Plugs	7
Breco Self Tracking Belt	127
Brush	85
Brushes	66
Bumpers	92
Bushing	87





C

Cable Carrier	85,86
Cable Carrier Brackets	86
Cable Cylinders	36
Cables	49
Cam Follower	88
Chain	134,135
Chipouts	170-173
Chisels	173
Chucks & Keys	174
Clutch	135
Coil Air Hose	16
Collars	88
Collet Wrench	196
Collets	174-177
Colombo Wrench	196
Contactors	51
Contacts	75
Control Transformer	67
Cord Grip	49
Corrosion Inhibitors	83
Counters	50
Coupler	136,137
Couplings	10
Cross	7
Cutter Head & Supplies	179
Cuttter Head Baldes	179
Cylinders Assemblies	37,38

D

Deep Drill	167
Deep Mortise Arbors	157,158
Demagnetizer	200
Dewalt	62
Diffuse Photo Eyes	68
Digital Pressure Switch	47
Din Rail	52
Disc Brake	137
Disconnect	51
Dowel Drill	165
Drum Switch	70
Dual Pushbutton	75
Dust Collection	83

E

Enclosures	80
Encoders	56
Ethernet Gateway	56
Exhaust Ball Valves	7
Exhaust Dump Valve	46

	Eye Bolt	112
F	Fabco - Mounting Hardware	26
	Fabco - Pancake Series	26,27,28
	Fabco - Repair Kit	28
	Fabco Air Valves	44
	Filters	41
	Finish Nut	116
	Flange Block Bearing	121
	Flanged Ball Bearing	123
	Flat Head Socket Head	112
	Flat Washer	116
	Flow Controls	13,14
	Foam	89
	Foot Switch Components	82
	Foot Valves	46
	Funnel Tubes	193,194
	Fuses	57
G	Gear Pump	89
	Gearbelt	128-131
	Gearbelt Pulley	137,138
	Gearboxes	139
	Gloved Hand Selector	78
	Grease Fitting	126
	Grease, Silicon Spray	83
	Grip Notch	130
H	Habasit Belts	131
	Hex Head	113-115
	High Speed Drill Bit	165,166
	Hoist Ring	89
	Humphrey	38,39,40
	Hydraulic Reservoir	40
I	Idler	138
	Idler Shaft	92
	Illuminated	74
	Indicator Lights & Lamps	53
K	Keys	79
	Kip Handles	90,91
	Knobs	92-94
	KVAL Apparel	200
L	Light Module	53
	Limit Switch	72
	Limit Switch Arm	73
	Limit Valves	46



	Linear Bearing	126
	Lock Washer	115
	Lovejoy	138,139
	Lovejoy Spider	139
	Lubricants	84
	Lubricator	41
M	MAC Valves	43,45
	Mac Air Piloted Valves	45
	Magnets	194
	Manifolds	45
	Microsmart	55
	Motion Controllers	62
	Motor - Colombo	62
	Motor - Dayton	62
	Motor - Ekstrom-Carlson	62
	Motor - Leeson	64
	Motor - Perske	64
	Motor - Servo Amplifiers	63
	Motor - Servo Motors	63
	Motor- Baldor	61
	Mufflers	48
	Multi Spur Bits	166,167
	Mushroom Illuminated Push/Pull Lens	78
	Mushroom Push/Push Lens	76
	Mushroom Pushbuttons	76
	N	Non-Illuminated
Nozzle		47
O	Oil Filter	89
	Oneshot Valve	47
	Open Pillow Block Bearing	125
P	Overload	52
	Pads	94-99
	Paint	84
	Parker Push-lok Hose Union	10
	Photo Eye Mounting Bracket	70
	Pillow Block	122,125
	Pilot Light Lens	76
	Pipe Sealant	83
	Plastic Fiber Optic	74
	PLCs- FA Series	55
	Plugs	50
	Porter Cable	65
	Potentiometer	77
	Power Block	80
	Power Supply	56
Pressure Gauges	99	

Q
R

Proximity Switches	69
Pulley	140
Pump Wrench	196
Pushbutton Button Cover	16,76
Pushbutton Legend Plate	86
PushButton Station	72
Quick Disconnect	11
Radial Ball Bearing	124
Rail Standoff	98
Reducer Bushings	11
Reducer Couplings	11
Regulators	42
Relays	54
Replacement Blades	162
Retaining Ring	119
Rod End	100
Roll Pin	119
Rolls	101
Router Bits	159,160
Rubber Rings	194
Safety Labels	146-151
Safety Light Screen	82
Safety Screens	152-155
Sanding Belts	179
Saw Blades	180
Screw Receivers	195
Screwdriver Chucks	178
Screwdriver Parts	163
Screwdrop Hose	194
Seals	141
Selector Switch	79
Self Aligning Coupler	102
Self Centering	154
Sensors for Columbo Motor	62
Servo Motors & Amplifiers	63
Shaft Wrench	197
Shock Absorber	102
Shoulder Bolt	118,119
Shuttle Valves	47
SIPP Gun	198
Sleeve Valves	46
Slotting Cutter	200
SMC 3-Way Low Wattage Valve	43
SMC 4-Way Valve	43,44
SMC Air Fittings	12,13
SMC Air Piloted Valves	49
SMC Base & Manifold	48

S





SMC Blank & Pigtails	42
SMC Pressure Gauge	42
SMC Mini Solenoid	43
Solenoid Valves	44
Solid Carbide	164
Spanner Wrench	197
Speed Reducer	142
Spherical Bearing	126
Spin-On Bits	161,162
Spiral Wrap	103
Splice Kit & Gun	134
Split Shells	195
Split Shells Springs	195
Springs	103-106
Sprockets	143,144
Spur Gear	144
Srewdriver Bits	178
Steel Ring	194
Step Stand	89
Stop Pin	107
Storage	107
Street Elbow - 45 Deg	8
Street Elbow - 90 Deg	8
Street Tee	9
Surge Suppressor	80
Switch Parts Hardware	80
Tape Reader	108
Taper Bushings	144,145
Taper Roller Bearing	127
Tee	9
Tensioner	108
Terminal Blocks	80,81
T-Handle	177
Through Beam	71
Thrust Washers	117,118
Toggle Clamp	108,109
Tool Balancer	200
Tool Holder	178
Torque Limiter	142
Torque Wrench	177
Touschscreen	56
Twist Drill	167,168
Two stage Bits	169
Union Elbow	9
Urethane Belts	132

T

U

V	Vacuum	47
	Vacuum Gauge	47
	V-Belting	131-134
W	Wheels	109,110,111
	Wing Bits	169,170
	Wire Connectors	81
#	6 Shooter Parts	180-182





Making Quality Door and Jamb Machinery Since 1947

INNOVATION | QUALITY | HONESTY

Order Today!
Call 1.800.553.5825

Notes



Published on 11/15/2019